

Distribuitor în România - Gada Ceramic București

Str. Vlad Județu 48

<https://gadaceramic.ro/produs/gresie-elements-design/>

ELEMENTS DESIGN



Distribuito în România - Gada Ceramic București
Str. Vlad Județu 48
<https://gadaceramic.ro/produs/gresie-elements-design/>

Our values/

Made in Italy

Selezioniamo le migliori materie prime e, secondo canoni estetici e funzionali, le trasformiamo in prodotti che interpretano con creatività il gusto italiano. Utilizziamo in uguale misura passione e tecnologia, cura del dettaglio e precisione, chimica e cultura, estetica e attenzione all'ambiente. Per noi Made in Italy è racchiudere tutto questo in ogni singolo prodotto.

Made in Italy

We pick the very best raw materials and we follow aesthetics and functional criteria to turn them into products embodying Italian taste and excellence. We sharply combine passion and technology, creativity and accuracy, science and culture, and environmental friendliness. To all of us, Made in Italy means gathering these features into every single product.

Greenthinking

Recuperiamo il 100% dell'acqua, autoproduciamo il 65% dell'energia, differenziamo il 98% dei rifiuti. Siamo stati i primi del settore ceramico a ottenere la certificazione PEF e tra i primi a guadagnarci l'EPD, la FDES e la HPDC. La maggior parte dei nostri prodotti è compatibile con lo standard LEED - Leadership in Energy and Environmental Design. Questo per noi è Greenthinking: un promessa molto seria, un impegno quotidiano.

Greenthinking

We recycle 100% of our water, produce 65% of our energy, separate 98% of our waste. We were the first company in the ceramic industry to obtain PEF certification and were among the first to earn the EPD, the FDES, and the HPDC certifications. The majority of our products comply with the LEED - Leadership in Energy and Environmental Design - standard. Greenthinking implies a solemn promise, an everyday commitment.

GRES PORCELLANATO
PORCELAIN STONEWARE

Effetto resina
Resin effect

ELEMENTS DESIGN

Distribuito în România - Gada Ceramic București
Str. Vlad Județu 48
<https://gadaceramic.ro/produs/gresie-elements-design/>



ISPIRAZIONE/ INSPIRATION

Easy-chic

La linea Elements Design porta nelle stanze la sobrietà netta e morbida di un effetto resina dalle prestazioni strutturali altissime. Ispirata alla vita metropolitana, con la sua superficie matt minimal, la collezione veste di eleganza pacata pareti e pavimenti e dà il via libera ad accostamenti decorativi personalizzati.

Easy-chic

The Elements Design line brings to the rooms the neat and soft look of high-performing, resin-effect tiles. With its minimal matt surface inspired by metropolitan life, the collection embellishes walls and floors with relaxed elegance and blends gracefully with the most vibrant furnishings.

INDOOR

120x278 6 mm
120x120 9 mm
60x120 9 mm
20x120 9 mm
60x60 9 mm
30x60 9 mm
9,7x60 9 mm
esagona 9 mm

OUTDOOR

60x120 K2 20mm

9
FORMATI/
SIZES

3
SPESSORI/
THICKNESSES

Formati e spessori

Elements Design ha forme e dimensioni per ogni progetto. Si presenta sia con formati piccoli, come il brick lucido 7.5x30 cm, sia con grandi lastre da 120x278 cm. A fianco dallo spessore 9 mm dei formati tradizionali c'è il 6 mm dei grandi formati, così come il 20mm delle piastrelle K2 per esterni. L'esagona di 25x21,6 cm e il nuovo decoro Rombi affiancano il decoro 3D 50x110 cm in monoporosa, slanciando la personalità dell'ambiente.

Sizes and thicknesses

Elements Design fits any project. It alternates small sizes such as the glossy brick 7.5x30cm, with the large slabs of 120x278cm. The 9mm thickness of the traditional formats sits alongside the 6mm thickness of the big sizes and the 20mm of the K2 outdoor tiles. The 25x21.6cm hexagon, the single-fired, 3D 50x110cm tile and our brand new decoration, Rombi, make up a decoration set created to give a central flair to the collection.



7 COLORI/ COLORS

5 SUPERFICI/ SURFACES

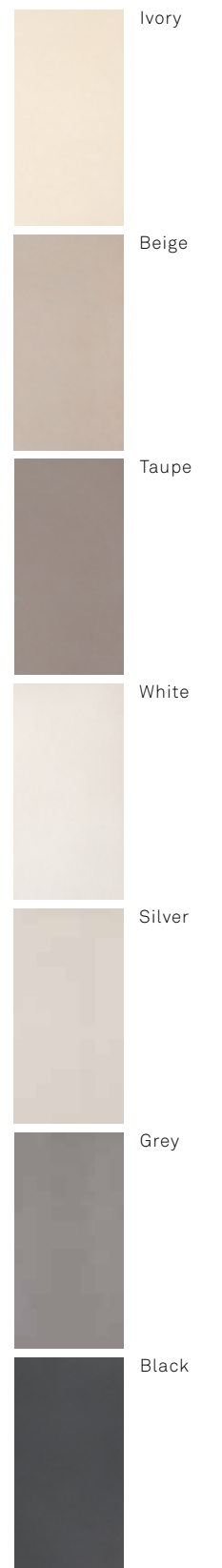

Colori e superfici

Sette toni compatti aprono la strada della creatività a chi progetta con Elements Design. Ivory, Beige, White e Silver si sintonizzano su frequenze di colore tenui e morbide; Black, Taupe e Grey, le gradazioni più intense, sono fatte per donare profonda intensità agli ambienti. La modernità delle superfici Elements Design sorprende in versione matt, lappata, glossy o strutturata (R10). I decori studiati per la collezione consentono infinite combinazioni, regalando effetti ottici giocati su chiaroscuri.

Colors and surfaces

Seven solid tones open the way for those working with the Elements Design range. Ivory, Beige, White and Silver work in soft and neutral color frequencies; Black, Taupe and Gray offer dark variations for sharp contrasts. Whether matt or structured R10 up to glossy, Elements Design's modernity has a huge capacity for surprise. The decorations were designed to furnish rooms with outstanding temper.

beige

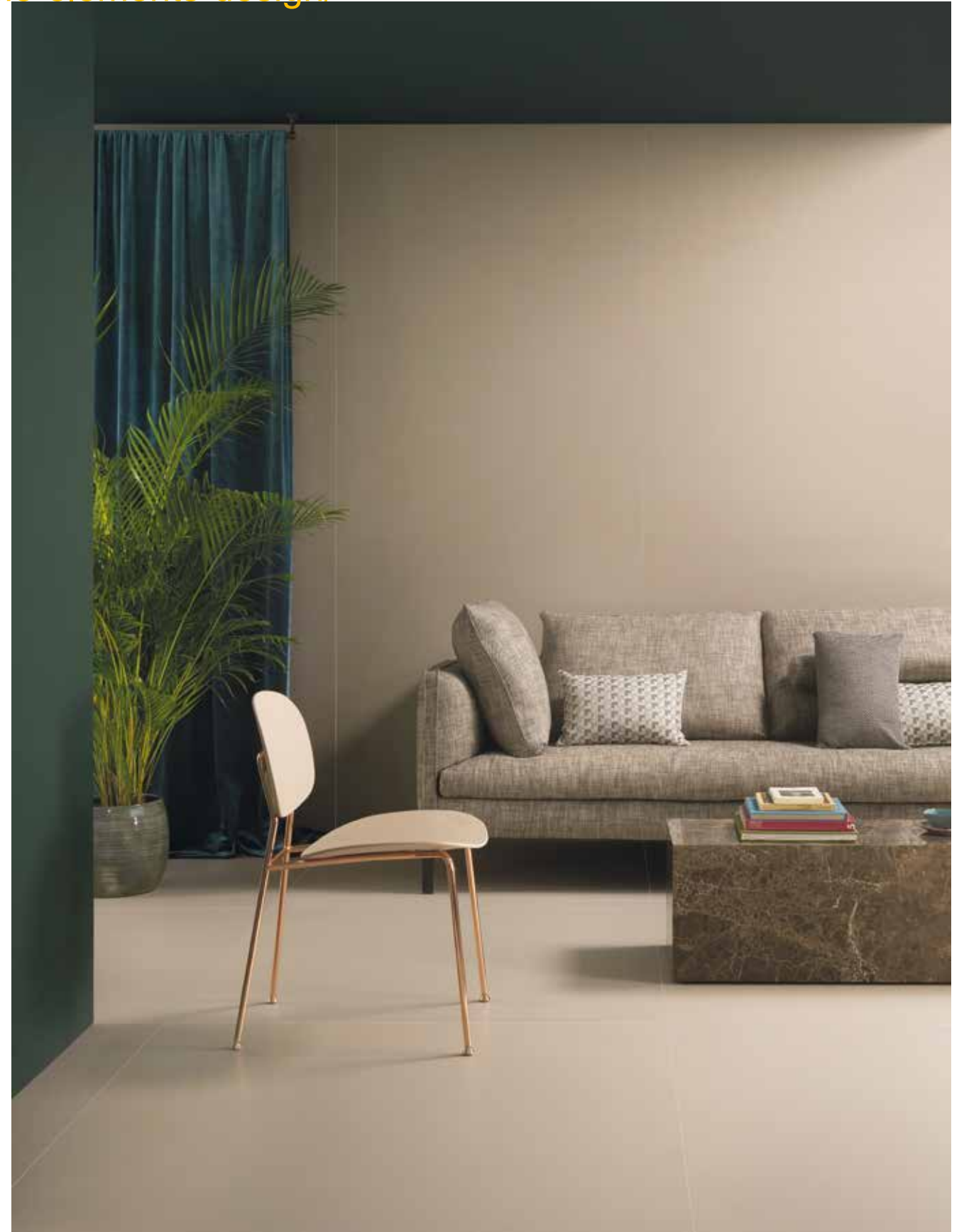

60x120 (24"x48")



elements design beige

Distribuitor în România - Gada Ceramic București

Str. Vlad Județu 48

<https://gadaceramic.ro/produs/gresie-elements-design/>



60x120 (24"x48")

elements design beige

black





120x120 (48"x48")

elements design black

120x120 (48"x48")
E. LUX CALACATTA
120x240 (48"x96")



elements design black



60x60 (24"x24")

GLOSSY 7,5x30 (3"x12")

E.DESIGN WHITE 60x120 (24"x48")

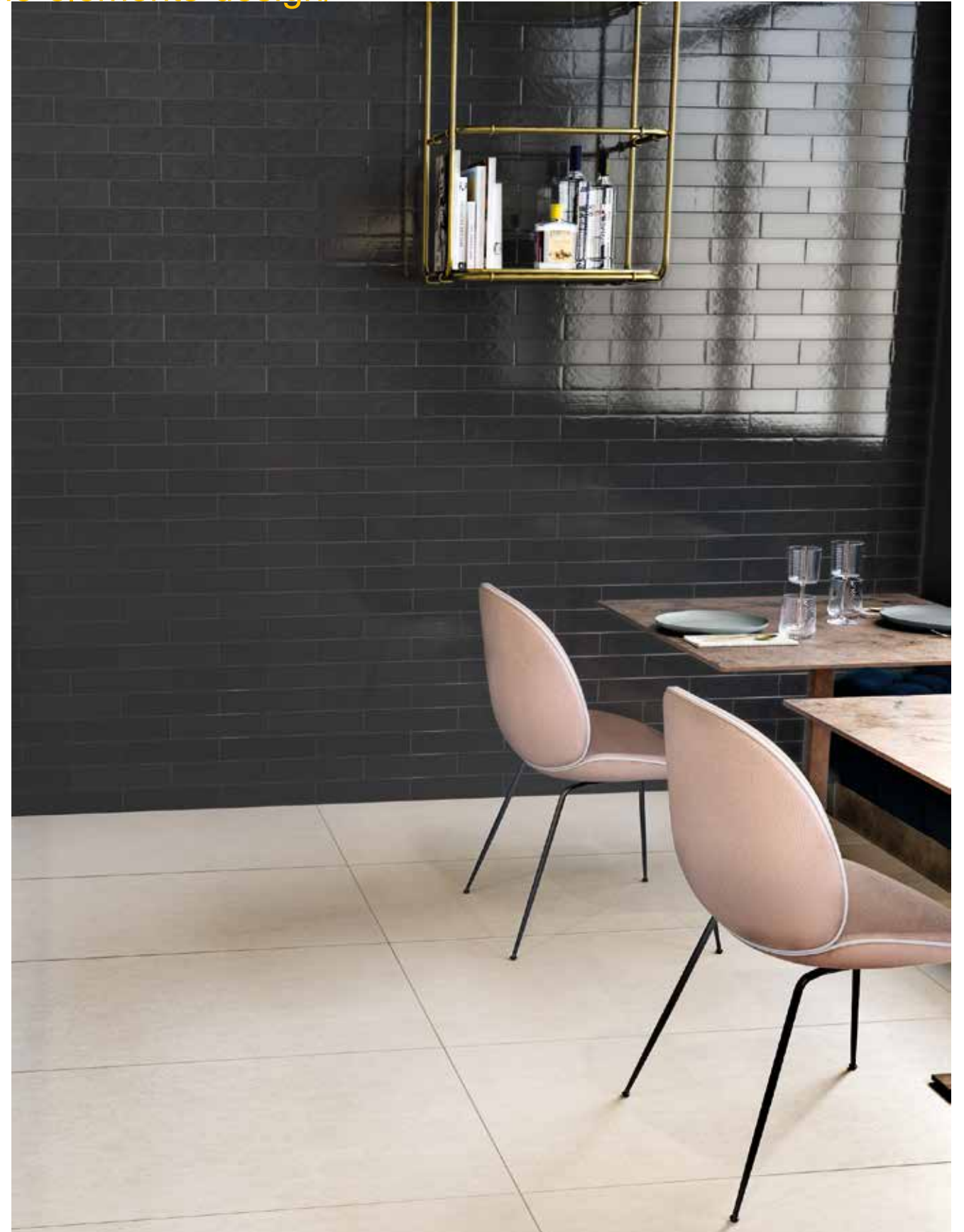

Distribuito în România - Gada Ceramic București
Str. Vlad Județu 48
<https://gadaceramic.ro/produs/gresie-elements-design/>

grey



elements design grey

Facciata e decoro dal progetto Plus Atelier disponibile su richiesta. Maggiori informazioni sul catalogo Plus Atelier.
Facade and decor from project Plus Atelier available upon request. More information on the Plus Atelier catalogue.



GLOSSY 7,5x30 (3"x12")

60x120 (24"x48")



60x120 (24"x48") Lappato

ivory



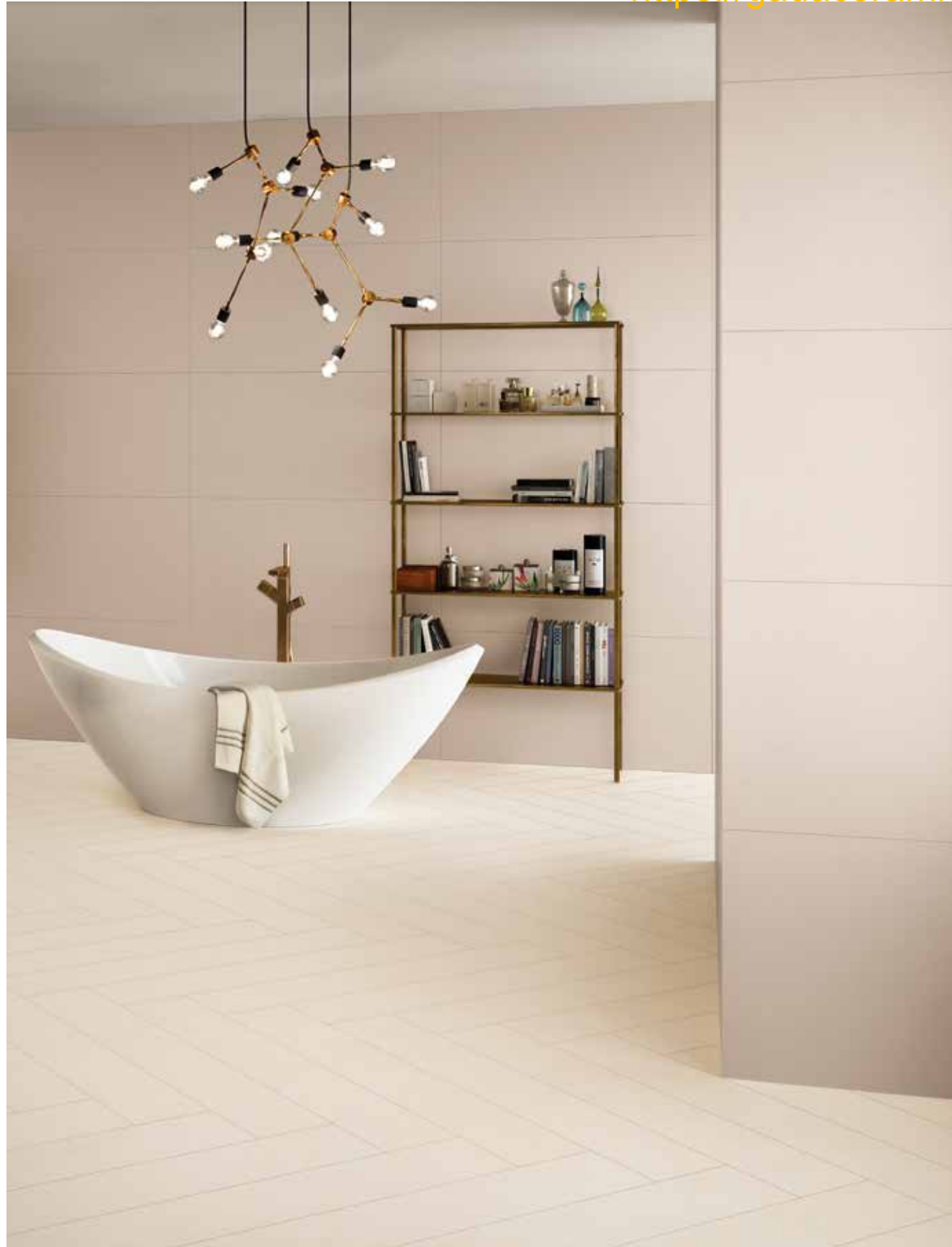

20x120 (8"x48")

E. DESIGN BEIGE
60x120 (24"x48")

MOSAICO HERRINGBONE
42x34,5 (16^{9/16}"x13^{9/16}")

60x120 (24"x48")
E. DESIGN MIX ESAGONE
25X21,6 (10"x8^{5/8}")



elements design ivory

silver





60x120 (24"x48")
E. LUX PORT LAURENT
20x120 (8"x48")

60x120 (24"x48")

GREY GLOSSY
7,5x30 (3"x12")

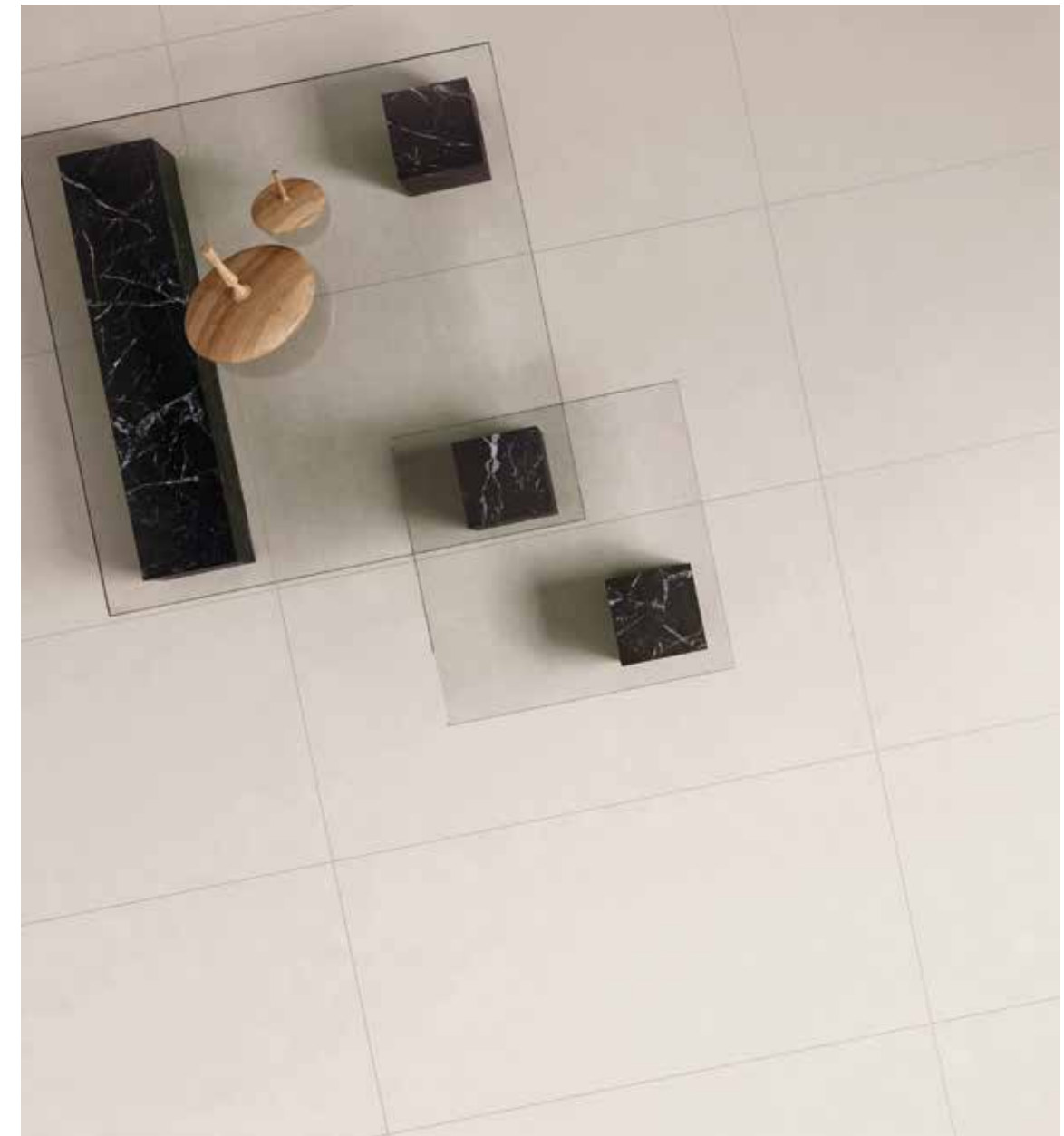

60x120 (24"x48")

taupe



120x120 (48"x48")

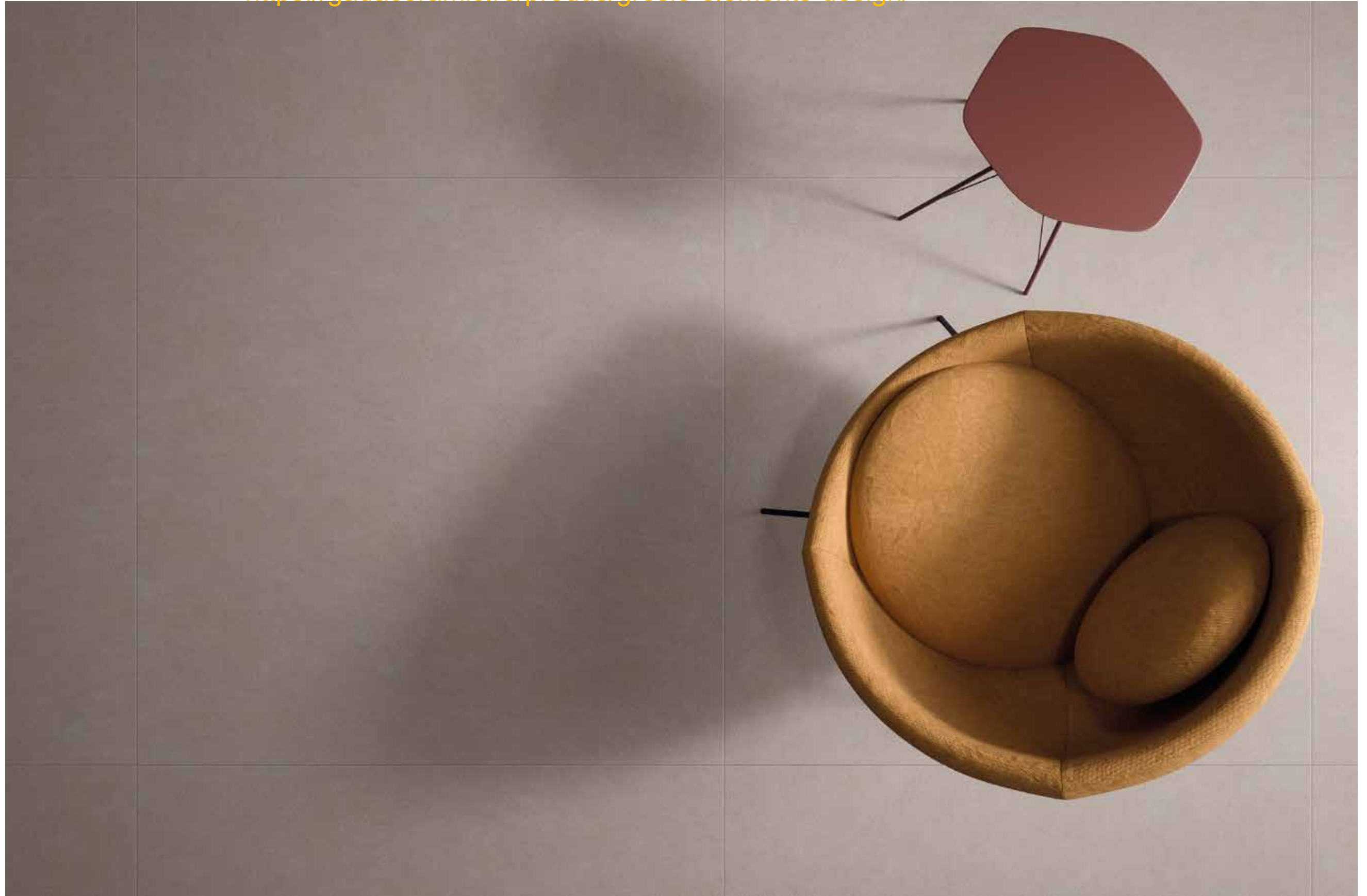

elements design taupe



60x120 (24"x48")

120x120 (48"x48")
MOSAICO ROMBI COLD 30,5x35,2 (12^{1/16}"x13^{7/8}")



elements design taupe

white





120x120 (48"x48")



60x120 (24"x48") K2 20 mm
ANGOLARE GRIGLIA
15x60 (6"x24") K2 20 mm
GRIGLIA
15x60 (6"x24") K2 20 mm
TERMINALE L
120x45x15 (48"x18"x6") K2 20 mm
TOP BORDO TORO
30x60 (12"x24") K2 20 mm



LAVELLO A COLONNA
COLUMN SINK



DISPONIBILE IN / AVAILABLE IN
50x50x85 cm

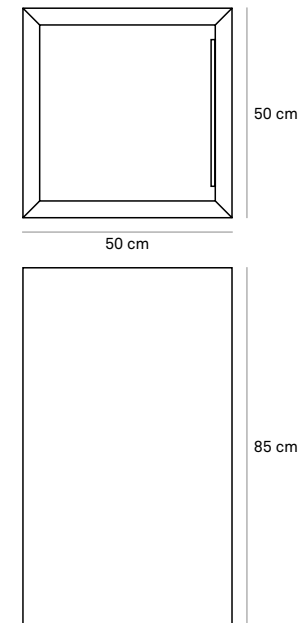

LAVELLO DA APPOGGIO
COUNTERTOP SINK



DISPONIBILE IN / AVAILABLE IN
35x50x12 cm

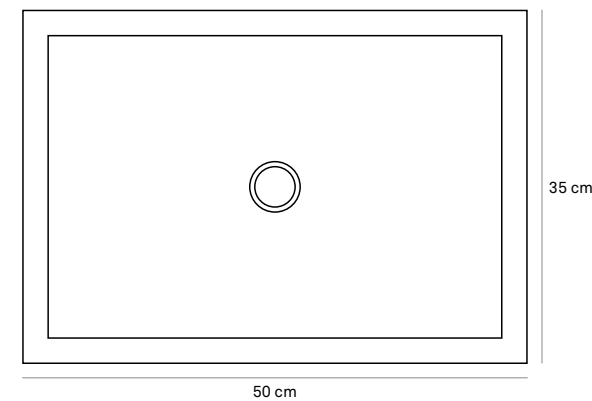

DISPONIBILE IN / AVAILABLE IN
50x120x12 cm
50x160x12 cm

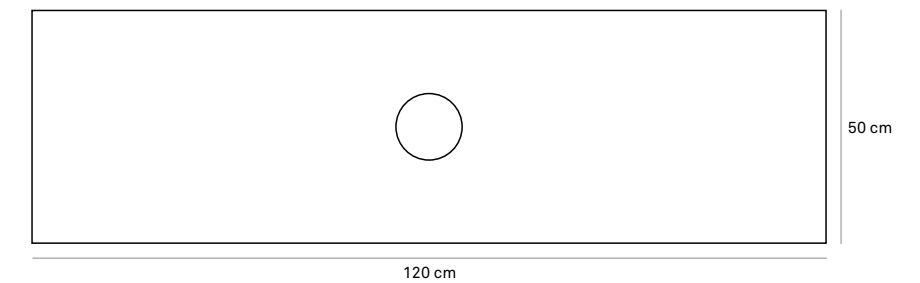



PIATTO DOCCIA*
 SHOWER TRAY



DISPONIBILE IN / AVAILABLE IN
 80x120 cm
 80x135 cm
 90x135 cm
 90x160 cm

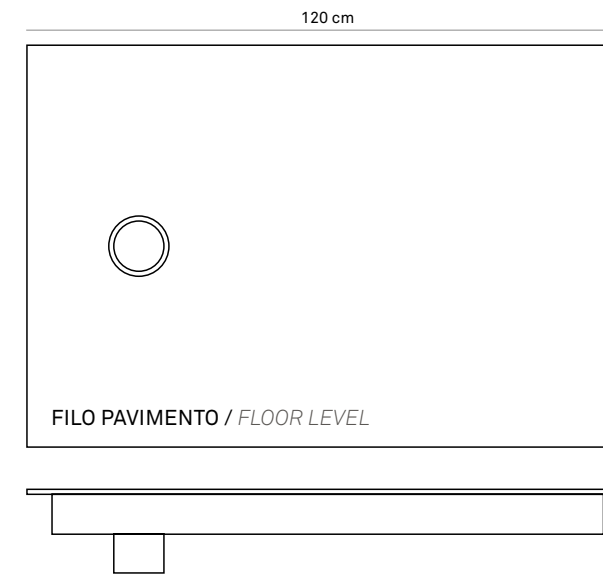

DISPONIBILE IN / AVAILABLE IN
 80x120x4 cm
 80x135x4 cm
 90x135x4 cm
 90x160x4 cm

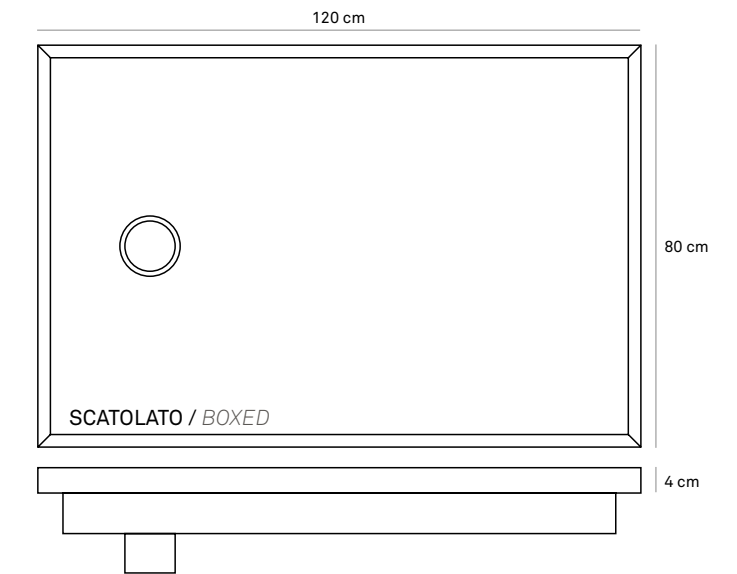

TAVOLINO CIRCOLARE
 CIRCULAR TABLE



DISPONIBILE IN / AVAILABLE IN
 Ø 42 cm H 50 cm
 Ø 58 cm H 50 cm
 Ø 73 cm H 39 cm

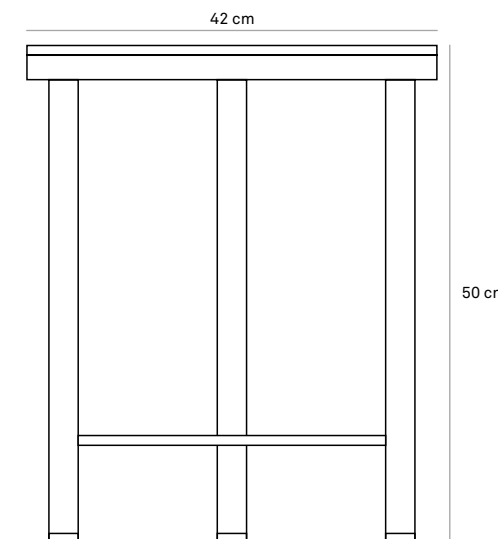

IT_
***Attenzione.** Per ottenere una superficie antiscivolo nel piatto doccia è necessario stendere un tappeto idoneo ad assicurare una presa sicura del piede in presenza di acqua.

EN_
***Warning.** To obtain a non-slip surface in the shower tray it is necessary to lay down a carpet suitable to ensure a secure grip of the foot in the presence of water.

HOME DECOR



TAVOLO RETTANGOLARE
RECTANGULAR TABLE



DISPONIBILE IN / AVAILABLE IN
95x200x75 cm



DISPONIBILE IN / AVAILABLE IN
95x175x75 cm

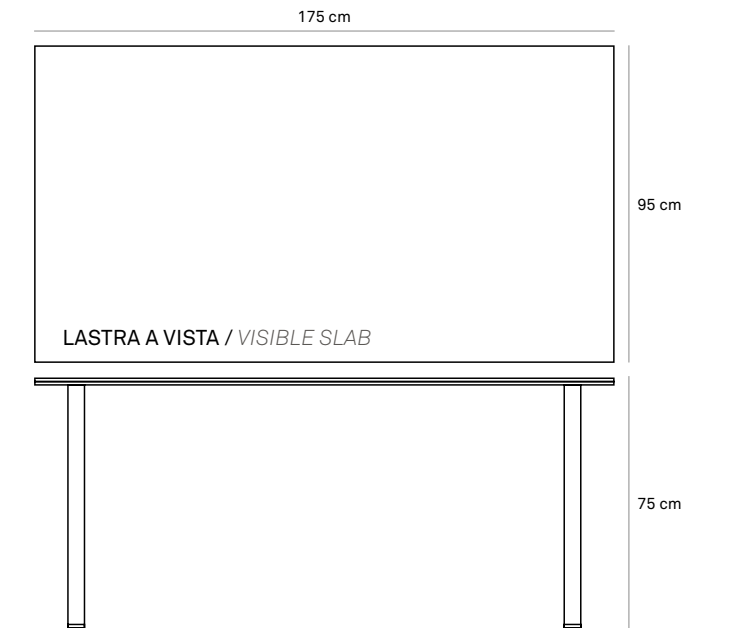

TAVOLO PLUS ATELIER
PLUS ATELIER TABLE

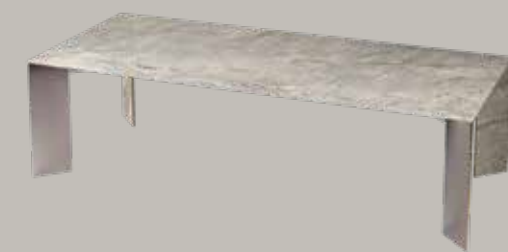

PERSONALIZZABILE IN DIMENSIONE E COLORE / CUSTOMIZABLE IN SIZE AND COLOR

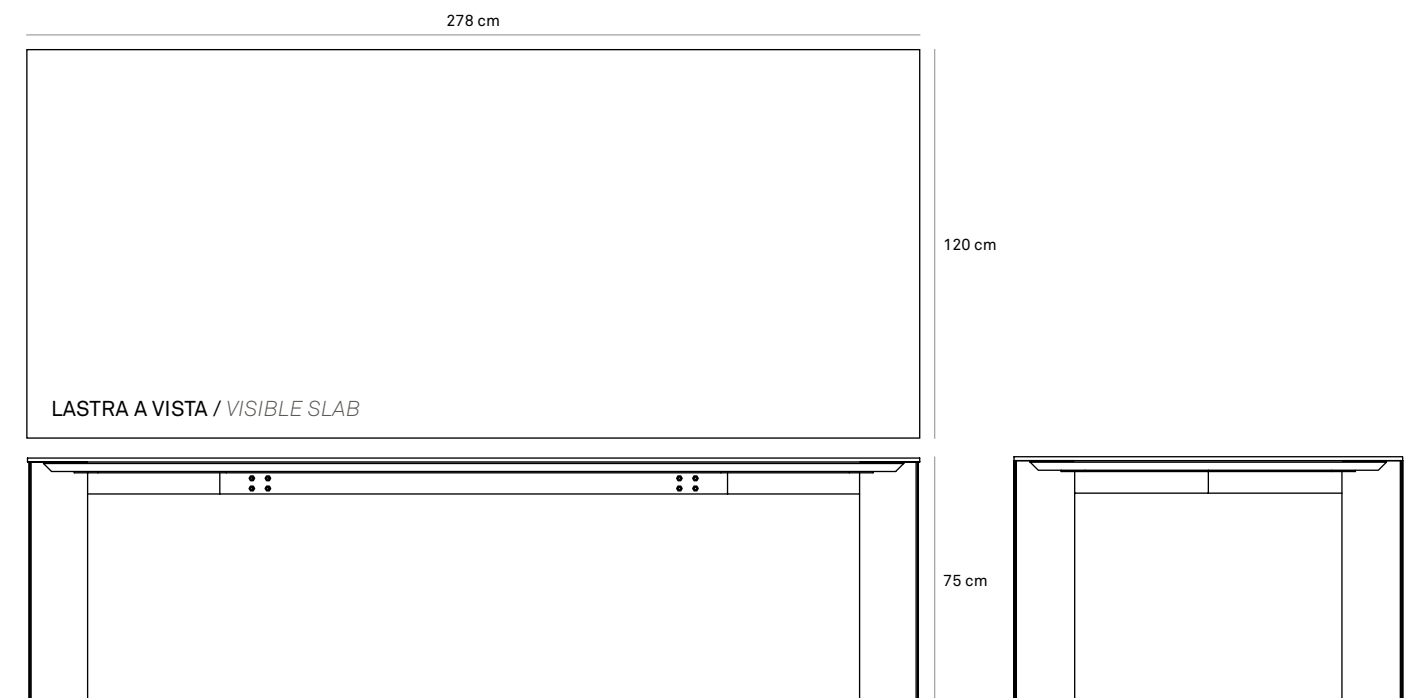

ELEMENTS DESIGN

SPECIFICHE TECNICHE/ TECHNICAL FEATURES

GRES PORCELLANATO TUTTA MASSA UGL/GL
FULL-BODY PORCELAIN UGL/GL

SPESSORI *THICKNESSES*

6 mm (120x278)
9 mm (120x120 - 60x120 - 20x120 - 60x60 - 30x60 -
25x21,6 Esagona)
20 mm (60x120)
8,5 mm (7,5x30 Glossy)

STONALIZZAZIONE *SHADING*



CLASSIFICAZIONE ANTISDRUCCIOLO *ASSESSMENT OF SLIP RESISTANCE*

DIN 51130 R9 - R10 - R11
DIN 51097 A - A+B - A+B+C
COF Conforme/ *Compliant*
DCOF Conforme/ *Compliant*
PENDULUM + 36 PTV 96 60x120 - 60x60 - 30x60

GRES PORCELLANATO /
PORCELAIN STONEWARE

GREENTHINKING /
GREENTHINKING



INATTACCABILE DA ACIDI /
NOT ATTACKED BY ACIDS



RESISTENTE A GELO E SHOCK TERMICI /
RESISTANT TO FROST AND SUDDEN THERMAL CHANGES



100% ACQUE REFLUE RECUPERATE /
100% RECOVERED WASTE WATER



ENERGIA AUTO-PRODOTTA DA FOTVOLTAICO /
ENERGY SELF-PRODUCED BY PV PLANT



FACILMENTE PULIBILE /
EASY TO CLEAN



RESISTENTE A SFORZI ED ABRASIONI /
RESISTANT TO STRESSES AND ABRASION

500 Kg/cm² di pressatura meccanica e cottura a 1.250°C /
500 kg/cm² of mechanical pressing and firing at 1250°C



98% RIFIUTI AVVIATI A RACCOLTA DIFFERENZIATA /
98% WASTE SENT TO SEPARATE COLLECTION



*** + 5.000.000 L = 3.000.000**

ACQUE DI PROCESSO DA ALTRI STABILIMENTI /
PROCESS WATER FROM OTHER FACTORIES



ANTIDRUCCIOLO /
ANTI-SLIP

per ambienti bagnati e outdoor /
for outdoor and wet environments



STABILE CROMATICAMENTE /
CHROMATICALLY FAST

inalterabile da agenti atmosferici e smog /
unchanged by weather agents and smog



100% PALLET FAO /
100% FAO PALLETS



*** 18.408 t = 570**

MATERIE PRIME NON ESTRATTE GRAZIE AL RECUPERO DI SCARTI /
NON-EXTRACTED RAW MATERIALS THANKS TO THE RECOVERY OF SCRAPS



NON REAGISCE AL FUOCO /
DOES NOT REACT TO FIRE

non emette fumi in caso di incendio /
does not release fumes in case of fire



ASSORBIMENTO H₂O NULLO /
NULL H₂O ABSORPTION



100% SCARTI CRUDI RECUPERATI /
100% RECOVERED RAW SCRAPS



*** + 24.000 MWh/year = 185.000**

84% ENERGIA AUTO PRODOTTA DA IMPIANTI DI COGENERAZIONE /
84% ENERGY SELF-PRODUCED BY COGENERATION PLANTS

IVORY



BEIGE

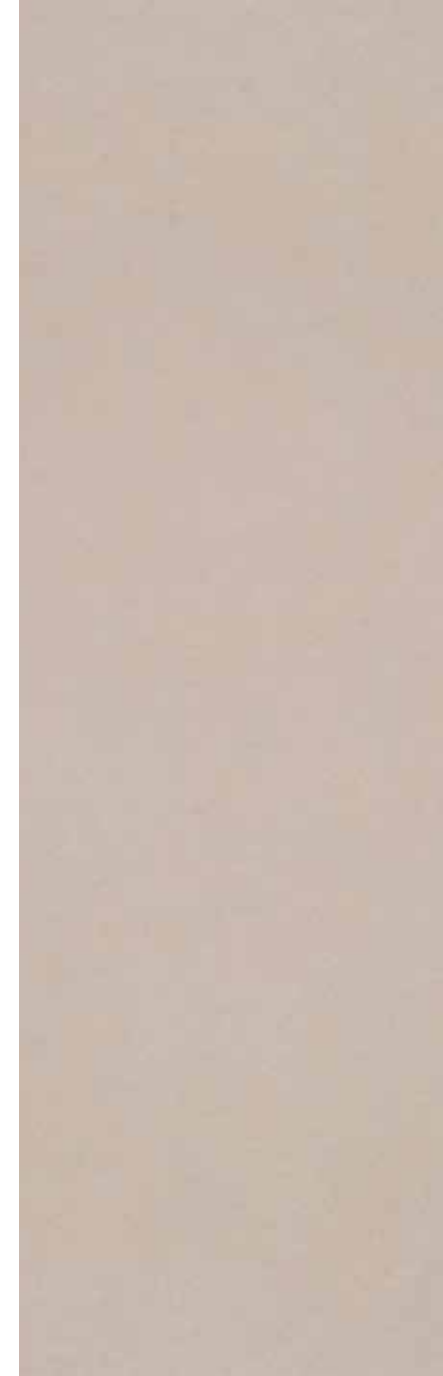

TAUPE



WHITE



SILVER



GREY



BLACK



IVORY V1

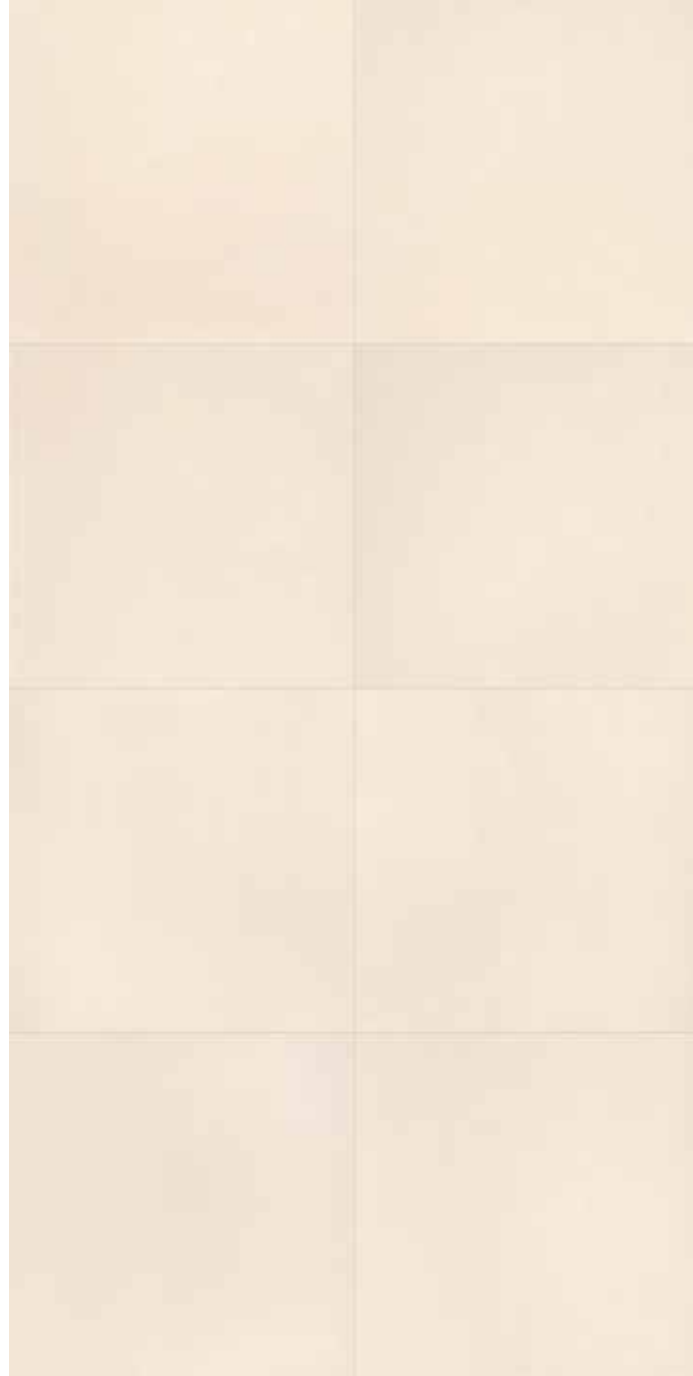

BEIGE V1

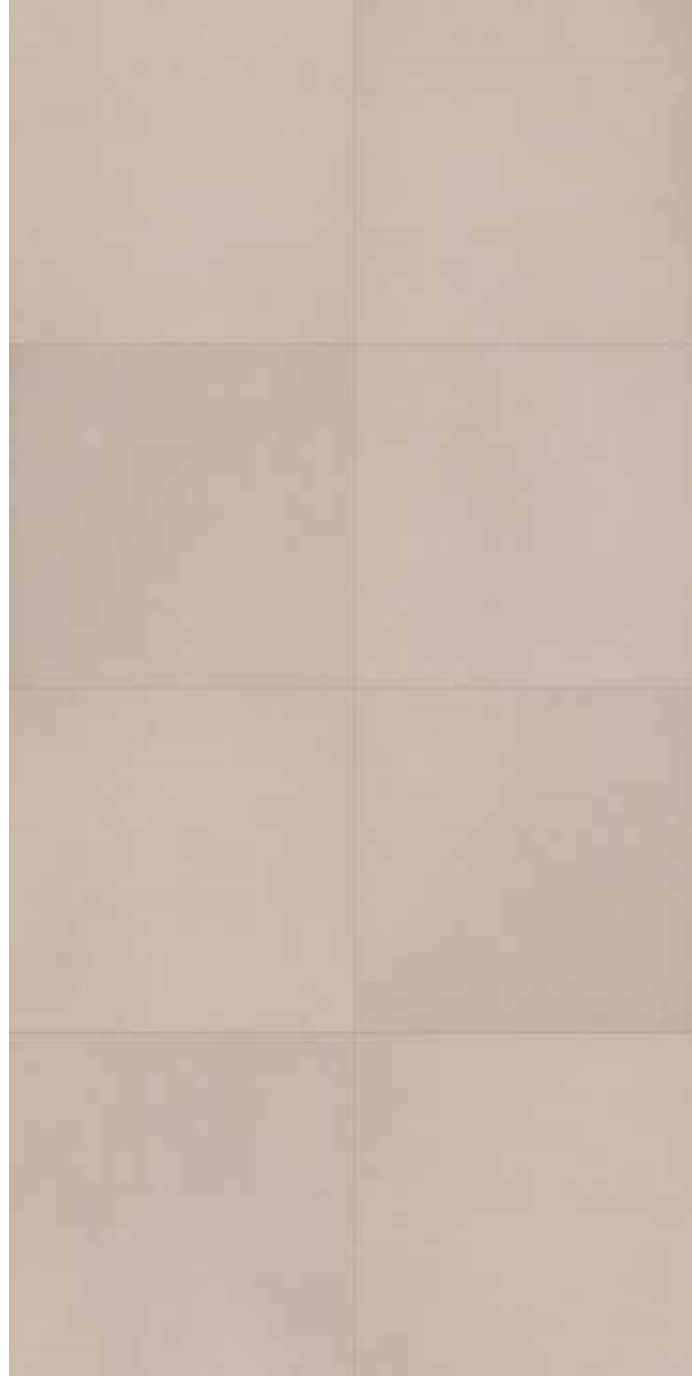

TAUPE V1



WHITE V1

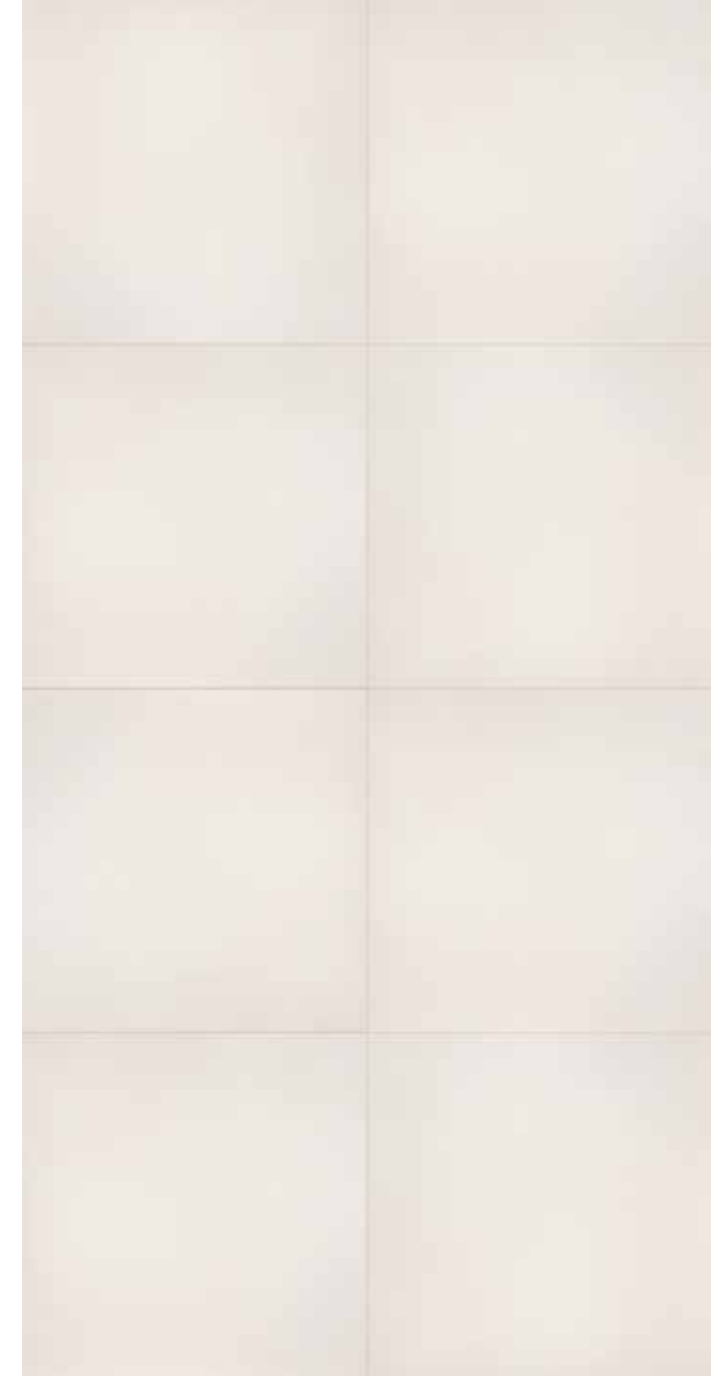

SILVER **V1**

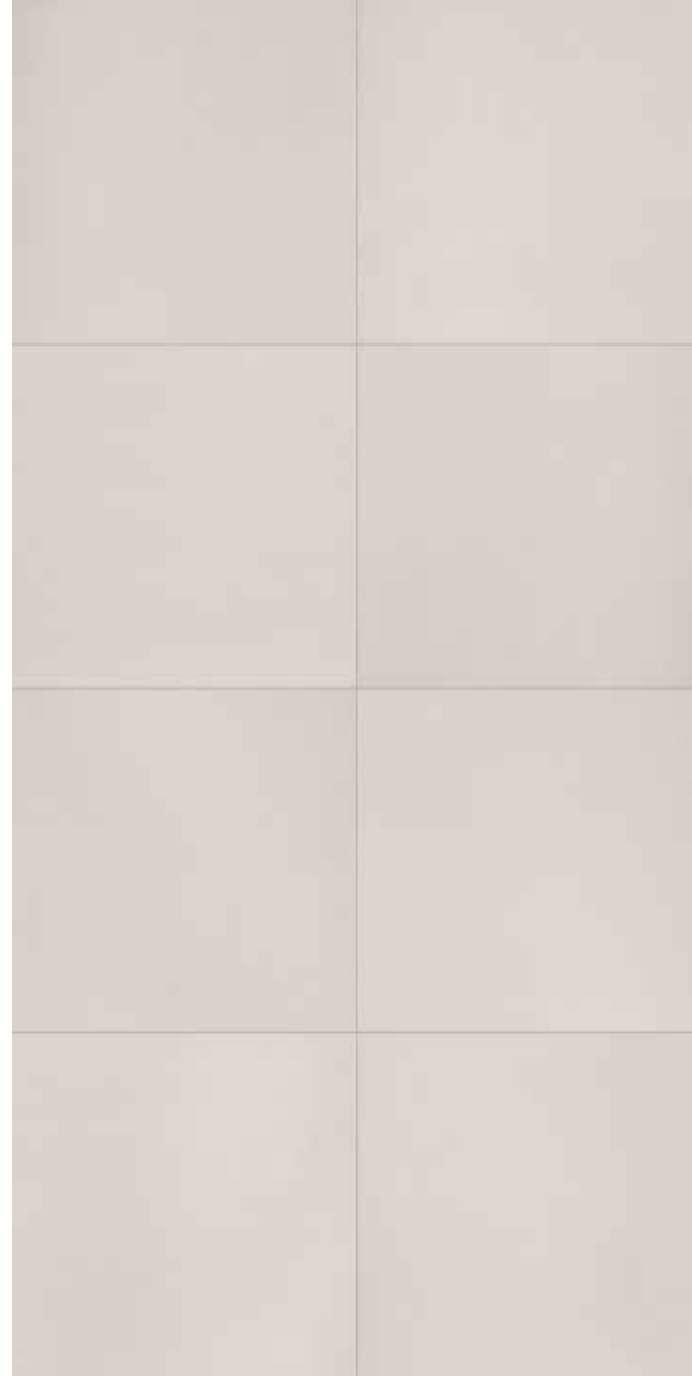

GREY **V1**



BLACK **V1**



9

FORMATI/ SIZES



● 120x278 (48"x110 ") RT 6 mm

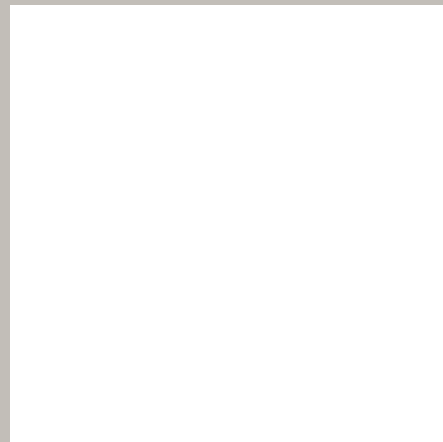

● 120x120 (48"x48") RT 9 mm

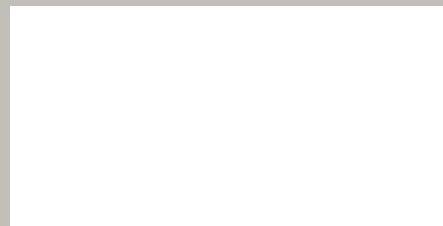

● ■ ◆ 60x120 (24"x48") RT 9 mm
▲ 60x120 (24"x48") RT K2 20 mm



● 20x120 (8"x48") RT 9 mm

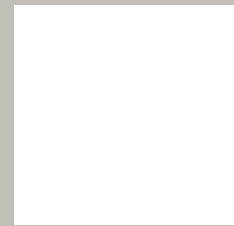

● ■ ◆ 60x60 (24"x24") RT 9 mm



● ■ 30x60 (12"x24") RT 9 mm



● 25x21,6 (10"x8^{5/8}") N.RT 9 mm



● 9,7x60 (3^{7/8}"x24") RT 9 mm



ELEMENTS DESIGN IVORY GLOSSY



ELEMENTS DESIGN BEIGE GLOSSY



ELEMENTS DESIGN TAUPE GLOSSY



ELEMENTS DESIGN WHITE GLOSSY



ELEMENTS DESIGN SILVER GLOSSY



ELEMENTS DESIGN GREY GLOSSY



ELEMENTS DESIGN BLACK GLOSSY

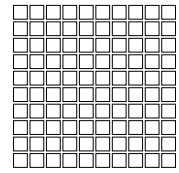

MOSAICO ● 30x30 (12"x12") RT 9 mm
(TESSERE: 2,8x2,8 - 11/16"x11/16")



E. DESIGN IVORY



E. DESIGN BEIGE

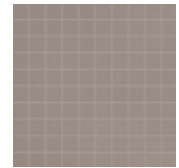

E. DESIGN TAUPE



E. DESIGN WHITE



E. DESIGN SILVER



E. DESIGN GREY



E. DESIGN BLACK



CHEVRON DX ● 10x59 (4"x24") RT 9 mm



CHEVRON SX ● 10x59 (4"x24") RT 9 mm



E. DESIGN IVORY



E. DESIGN BEIGE



E. DESIGN TAUPE

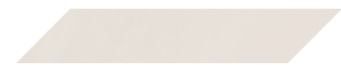

E. DESIGN WHITE



E. DESIGN SILVER



E. DESIGN GREY



E. DESIGN BLACK

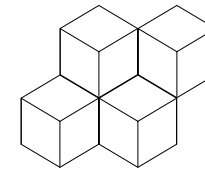

MOSAICO ROMBI
● 30,5x35,2 (12 1/16"x13 7/8") RT 9 mm



WARM (GREY - BEIGE - IVORY)



COLD (BLACK - GREY - SILVER)

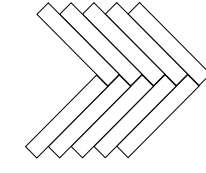

MOSAICO HERRINGBONE
● 42x34,5 (16 9/16"x13 9/16") RT 9 mm



E. DESIGN IVORY



E. DESIGN BEIGE



E. DESIGN TAUPE



E. DESIGN WHITE



E. DESIGN SILVER



E. DESIGN BLACK



E. DESIGN GREY

5

PEZZI SPECIALI/ TRIMS



BATTISCOPA
● 7,2x60 (2.8"x24") RT 9 mm

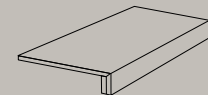

SCALINO INCOLLATO
● ■ 33x60 (13"x24") RT 9 mm



ANGOLARE INCOLLATO
● ■ 33x33 (13"x13") RT 9 mm

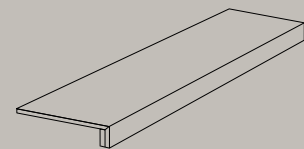

SCALINO INCOLLATO
● ■ 33x120 (13"x48") RT 9 mm

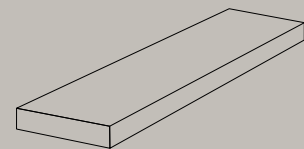

ANGOLARE INCOLLATO
● ■ 33x120 (13"x48") RT 9 mm

9

PEZZI SPECIALI K₂/ TRIMS K₂

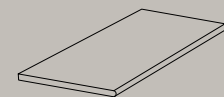

GRADINO BORDO CON TORO
▲ 60x120 (24"x48") RT 20 mm
▲ 30x120 (12"x48") RT 20 mm

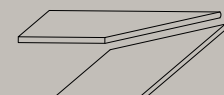

GRADINO ANGOLO ESTERNO BORDO CON TORO
▲ 60x120 (24"x48") RT 20 mm
▲ 30x120 (12"x48") RT 20 mm

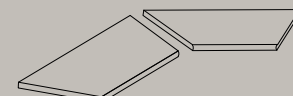

GRADINO ANGOLO INTERNO BORDO CON TORO
▲ 60x120 (24"x48") RT 20 mm
▲ 30x120 (12"x48") RT 20 mm



TERMINALE "L"
▲ 120x45x15 (48"x18"x6") RT 20 mm

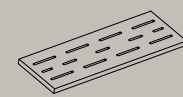

GRIGLIA
▲ 60x15 (24"x6") RT 20 mm

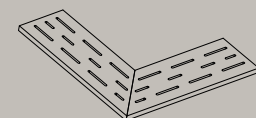

ANGOLARE GRIGLIA
▲ 60x15 (24"x6") RT 20 mm

SCHEMI DI POSA/ LAYING SYSTEM

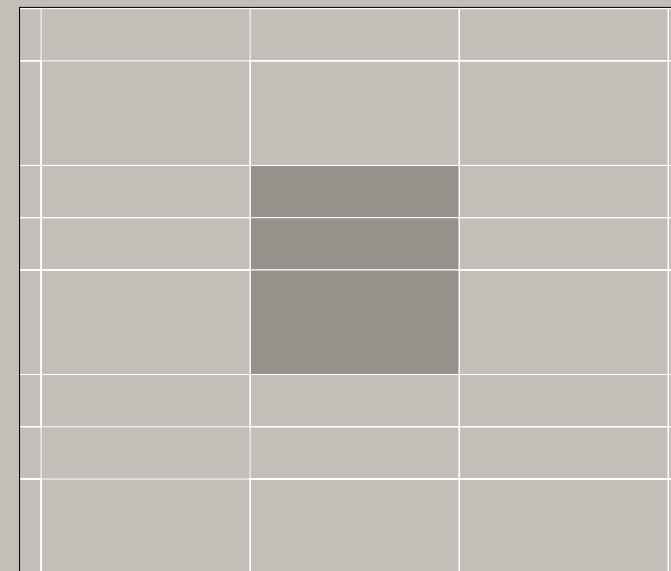

30x120 (12"x48") RT - 50,00%
60x120 (24"x48") RT - 50,00%

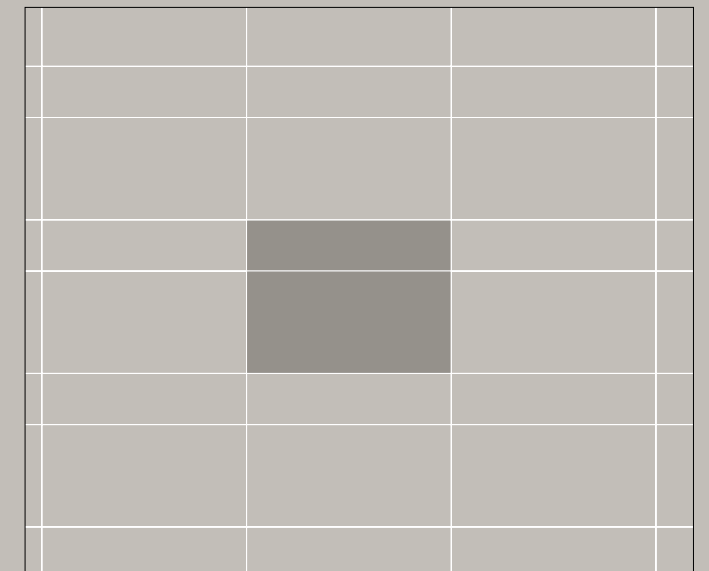

30x120 (12"x48") RT - 33,33%
60x120 (24"x48") RT - 66,66%

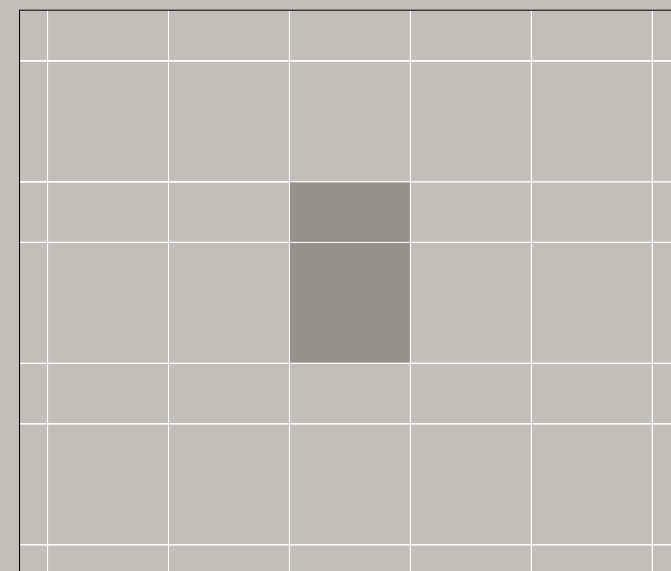

30x60 (12"x24") RT - 33,33%
60x60 (24"x24") RT - 66,66%

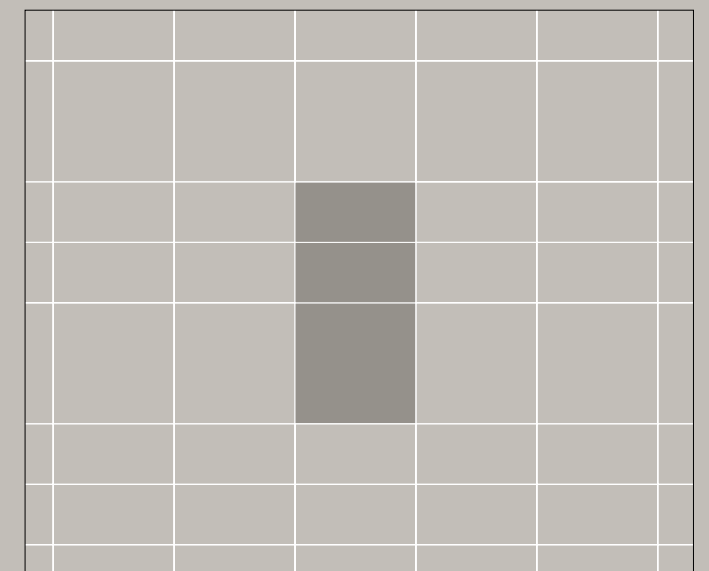

30x60 (12"x24") RT - 50,00%
60x60 (24"x24") RT - 50,00%

Fuga minima consigliata per posa in interno 2mm
Minimum suggested joint for indoor laying 2mm
Consigli di posa, pulizia e manutenzione al link keope.com
Consigli di posa, pulizia e manutenzione al link keope.com

Structured R11

Structured R10

Natural R9

Lappato

Glossy

FORMATI / SIZES

	120x278 (119,5x278)* 48"x110"	120x120 (119,5x119,5)* 48"x48"	60x120 24"x48"	20x120 8"x48"	60x60 24"x24"	30x60 12"x24"	9,7x60 3,78"x24"	60x120 24"x48"	25x21,6 10"x8,5/8"	7,5x30 3"x12"
working size	Esagona									
	1194x2778	1194x1194	596x1195	197x1195	596x596	297x596	97x596	596x1195		
	RT	RT	RT	RT	RT	RT	RT	RT	Not RT	Not RT
	6 mm	9 mm	9 mm	9 mm	9 mm	9 mm	9 mm	K2 20 mm	9 mm	8,5 mm
E.DESIGN IVORY		●	●■	●	●■	●■	●		●	★
E.DESIGN BEIGE	●	●	●■◆	●	●■◆	●■	●	▲	●	★
E.DESIGN TAUPE		●	●■	●	●■	●■	●		●	★
E.DESIGN WHITE	●	●	●■◆	●	●■◆	●■	●	▲	●	★
E.DESIGN SILVER		●	●■	●	●■	●■	●		●	★
E.DESIGN GREY	●	●	●■◆	●	●■◆	●■	●	▲	●	★
E.DESIGN BLACK		●	●■	●	●■	●■	●		●	★

*Formato nominale / Nominal size ● Natural ● Natural R9 ■ Structured R10 ▲ Structured R11 ★ Glossy ◆ Lappato

MISURE, PESI ED IMBALLI / SIZE, WEIGHT AND PACKAGING

FORMATO SIZE	SPESSORE THICKNESS	PZ/SCATOLA PIECES/BOX	MQ/SCATOLA SQM/BOX	KG/SCATOLA KG/BOX	MQ/PALLET SQM/PALLET	KG/PALLET KG/PALLET	SCATOLA/PALLET BOX/PALLET
120x278	6 mm	1	3,32	49,37	59,80	988,66	18
120x120	9 mm	2	2,86	60,80	57,12	1.229,00	20
60x120	9 mm	2	1,44	32,53	50,40	1.151,55	35
20x120	9 mm	6	1,44	29,13	46,08	945,16	32
60x60	9 mm	3	1,08	23,75	43,20	963,00	40
30x60	9 mm	7	1,26	25,00	50,40	1.013,00	40
9,7x60	9 mm	10	0,58	12,75	34,92	778,00	60
25x21,6 esagona Not RT	9 mm	29	1,18	23,36	42,38	853,96	36
60x120 K2	20 mm	1	0,72	33,75	25,20	1.194,25	35

INFORMAZIONI TECNICHE / TECHNICAL FEATURES

INFORMAZIONI TECNICHE TECHNICAL FEATURES	NORMA NORM EN 14411 - ISO 13006	REQUISITI PRESCRITTI REQUIRED VALUES	VALORI VALUES				
DIMENSIONI RETTIFICATO SIZES RECTIFIED	UNI EN ISO 10545-2	lunghezza-larghezza / length-width $\pm 0,3\%$ ($\pm 1,0$ mm max) spessore / thickness $\pm 5,0\%$ ($\pm 0,5$ mm max) ortogonalità / rectangularity $\pm 0,3\%$ ($\pm 1,5$ mm max) rettilinearità / straightness $\pm 0,3\%$ ($\pm 0,8$ mm max) planarità / flatness $\pm 0,4\%$ ($\pm 1,8$ mm max) qualità superficie / surface quality $\geq 95\%$	CONFORME COMPLIANT				
ASSORBIMENTO ACQUA WATER ABSORPTION	UNI EN ISO 10545-3	$\leq 0,5\%$	$\leq 0,1\%$				
RESISTENZA A ROTTURA BREAKING STRENGHT	UNI EN ISO 10545-4	R ≥ 35 N/mm ² S ≥ 700 N (<7,5 mm) S ≥ 1300 N ($\geq 7,5$ mm)	6 mm - 9 mm K2 20 mm CONFORME COMPLIANT R ≥ 45 N/mm ² S ≥ 10000 N				
RES. ABRASIONE PROFONDA (UGL - Matt) DEEP ABRASION RESISTANCE (UGL - Matt)	UNI EN ISO 10545-6	≤ 175 mm ³	≤ 150 mm ³				
RES. ABRASIONE SUPERFICIALE (GL - Lappato) SURFACE ABRASION RESISTANCE (GL - Lappato)	UNI EN ISO 10545-6	dichiarare un valore / declare a value	TEST DISPONIBILE TEST AVAILABLE				
RESISTENZA SHOCK TERMICI THERMAL SHOCK RESISTANCE	UNI EN ISO 10545-9	resistenza / resistant	CONFORME COMPLIANT				
RESISTENZA AL GELO FROST RESISTANCE	UNI EN ISO 10545-12	resistenza / resistant	CONFORME COMPLIANT				
RESISTENZA CHIMICA CHEMICAL RESISTANCE	UNI EN ISO 10545-13	resistenza / resistant	CONFORME COMPLIANT				
RESISTENZA ALLE MACCHIE RESISTANCE TO STAINS	UNI EN ISO 10545-14	pulibile / cleanable	CONFORME COMPLIANT				
	DIN 51130	R	prodotto / product	R	A+B+C	>0,40	>0,42
	DIN 51097	A+B+C	Esagona Not RT Natural	-	-	-	
			7,5x30 Not RT Glossy	-	-	-	
			60x120 Lappato - 60x60 Lappato	-	-	-	
CLASSIFICAZIONE ANTISDRUCCIOLO ASSESSMENT OF SLIP RESISTANCE	B.C.R.A. (COF)	>0,40 bagnato / wet	120x278 - 120x120 - 60x120 - 20x120 - 60x60 - 30x60	R9	A	CONFORME COMPLIANT	
	ANSI A137.1 2012 (DCOF)	>0,42 bagnato / wet	60x120 - 60x60 - 30x60	R10	A+B	CONFORME COMPLIANT	
			60x120 K2	R11	A+B+C	CONFORME COMPLIANT	
	Pendulum Test Value PTV 96 (R10)	> 36	60x120 - 60x60 - 30x60				

Piastrelle pressate a secco - Conforme alla norma EN 14411 e ISO 13006 appendice G gruppo B1-a con E $\leq 0,5\%$
Dry pressed tiles - Compliant with standards EN 14411 and ISO 13006 annex G group B1-a with E $\leq 0,5\%$

Distribuito în România - Gada Ceramic București
Str. Vlad Județu 48
<https://gadaceramic.ro/produs/gresie-elements-design/>

dicembre 2020



HEADQUARTER via statale 467, 21
42013 Casalgrande (RE) - Italy
FACTORY via canale, 67
42013 Casalgrande (RE) - Italy
WAREHOUSE via dell'industria, 1
42013 Casalgrande (RE) - Italy

PHONE +39 0522 997511
FAX +39 0522 997544 (OT) - 545 (IT)
ADMIN. FAX +39 0522 997413

info@keope.com
keope.com

IT_

Ceramiche Keope si riserva la facoltà di apportare variazioni ai prodotti illustrati in questo catalogo per necessità produttive o al fine di migliorarne la qualità. I campioni e le immagini sono puramente indicativi. Gli imballaggi e pesi riportati possono variare per necessità produttive. Consultare gli uffici commerciali al momento dell'ordine.

EN_

Ceramiche Keope reserves the right to vary the products illustrated in this catalogue for production purposes or in order to improve quality. Samples and images are purely indicative. Packaging and weights shown may be varied in line with production requirements. Check with the sales department at the time of order.

Distribuitor în România - Gada Ceramic București
Str. Vlad Județu 48
<https://gadaceramic.ro/produs/gresie-elements-design/>