

MEDLEY

CERAMICHE
SUPERGRES

Dall'incontro tra superfici materiche con texture lustrate, nasce Medley, la collezione in grès porcellanato declinata in quattro tonalità calde e contemporanee.

La valenza tecnica del grès porcellanato in 6 formati e del rivestimento in pasta bianca, permette la riproduzione di effetti cromatici di alto livello, esaltandone le tonalità morbide e naturali. Medley si compone di una vasta proposta di elementi di corredo e decori dalle dimensioni innovative e dai molteplici effetti superficiali, con strutture capaci di adattarsi a varie applicazioni e destinazioni d'uso. Il risultato è un progetto d'arredo contemporaneo, materico ed essenziale, che spazia tra grandi e piccoli formati. Dal formato 75x150, il grès porcellanato Supergres si declina nell'intramontabile 20x20, arrivando alla soluzione del mattoncino 7,5x30 che rappresenta la perfetta sintesi tra tradizione e design moderno. Completa la gamma dei formati, il rivestimento 25x75 in pasta bianca, la soluzione ideale per soddisfare ogni esigenza progettuale.

Con questa nuova collezione, Supergres offre al panorama dell'architettura contemporanea una soluzione che abbina colori, strutture e superfici per vestire gli spazi con atmosfere morbide e avvolgenti.

MEDLEY

Medley comes from the meeting between textile-effect surfaces and delicately polished textures, a porcelain stoneware collection available in four warm and contemporary shades. The technical value of porcelain stoneware tiles in six sizes and white-body finish allows reproducing high-quality chromatic effects, enhancing the soft and natural tones. Medley features a wide range of decorative elements with innovative dimensions and multiple surface effects structured to adapt to various applications and uses. The result is a textural and essential contemporary décor project ranging from small to large sizes. The Supergres porcelain stoneware tiles range from a size of 75x150, to the evergreen 20x20, and down to the 7.5x30 brick that perfectly blends tradition and modern design. The range of sizes is completed by the 25x75 white-body wall tile, the ideal material for any design requirement. With this new collection, Supergres offers contemporary architecture a solution that combines colours, structures and surfaces to create soft, enveloping atmospheres.

De la rencontre entre surfaces matériques aux textures agréablement brillantes, est née Medley, la collection en grès cérame déclinée en quatre tons chauds et contemporains. La valeur technique du grès cérame en 6 formats et du revêtement en pâte blanche, autorise la reproduction d'effets chromatiques de haut niveau, mettant en valeur leurs tons doux et naturels. Medley se compose d'une offre étendue d'éléments d'équipement et de décors aux dimensions innovantes et aux multiples effets de surface avec des structures pouvant s'adapter à une diversité d'applications et d'utilisations possibles. Il en résulte un projet d'aménagement contemporain, matérique et essentiel, qui va des grands aux petits formats. Du format 75x150, le grès cérame Supergres se décline dans l'indémontable 20x20, jusqu'à la solution de la brique 7,5x30 qui opère la synthèse parfaite entre tradition et design moderne. Pour compléter la gamme des formats, le revêtement 25x75 en pâte blanche, la solution idéale pour satisfaire toute exigence de conception. Avec cette nouvelle collection, Supergres fournit à l'univers de l'architecture contemporaine une solution qui combine couleurs, structures et surfaces pour conférer aux espaces des atmosphères douces et accueillantes.

Aus der Begegnung zwischen Oberflächen mit Materialcharakter und angenehm glänzenden Texturen ist Medley entstanden, die Wandfliesenkollektion aus Feinsteinzeug in vier warmen und modernen Farbtönen. Die technischen Eigenschaften dieser weißscherbigen Wandfliesen aus Feinsteinzeug, die in 6 Größen erhältlich sind, erlauben die Nachahmung von Farbeffekten auf hohem Niveau, dabei kommen die samtigen und natürlichen Farbtöne voll zur Geltung. Medley bietet eine breite Palette von Sonderteilen und Dekoren in innovativen Größen mit vielfältigen Oberflächeneffekten. Die Strukturen passen zu ganz unterschiedlichen Anwendungen und Verwendungszwecken. So entsteht ein modernes Einrichtungsprojekt mit einem großen Angebot an kleinen und großen Formaten, bei dem Materialcharakter und Schlichtheit im Vordergrund stehen. Im Programm von Supergres findet man das große Format 75x150 ebenso wie die zeitlose quadratische Fliese mit den Abmessungen 20x20 und den Ziegel 7,5x30. So wird ist eine perfekte Balance zwischen Tradition und modernem Design möglich. Die weißscherbige Wandfliese mit den Abmessungen 25x75 ergänzt das Sortiment und ist die ideale Lösung für jede Projektanforderung. Mit dieser neuen Kollektion ist Supergres durch die Kombination von Farben, Strukturen und Oberflächen mit zarter und gemütlicher Ausstrahlung die ideale Lösung für moderne Architekturprojekte.

De la unión de superficies matéricas con texturas agradablemente brillantes nace Medley, la colección de gres porcelánico disponible en cuatro tonalidades cálidas y modernas. El valor técnico del gres porcelánico en 6 formatos y del revestimiento de pasta blanca permite la reproducción de efectos cromáticos de alto nivel, destacando los tonos suaves y naturales. Medley se compone de una amplia propuesta de elementos de decoración de tamaños innovadores y de múltiples efectos superficiales con estructuras capaces de adaptarse a varias aplicaciones y usos. El resultado es un proyecto de decoración contemporáneo, matérico y esencial que abarca tanto los grandes como los pequeños formatos. Del formato 75x150, el gres porcelánico Supergres se articula en el eterno 20x20, llegando a la solución del ladrillo 7,5x30, que representa la unión perfecta entre tradición y diseño moderno. Completa la gama de formatos el revestimiento 25x75 de pasta blanca, la solución ideal para satisfacer todas las necesidades del proyecto. Con esta nueva colección, Supergres ofrece al panorama de la arquitectura contemporánea una solución que combina colores, estructuras y superficies para decorar los espacios con ambientes suaves y acogedores.

Коллекция керамического гранита Medley представляет собой ассортимент керамической плитки, отличающейся тактильной поверхностью с нежным блеском текстуры четырех теплых оттенков цвета. Высокие технические характеристики керамогранита, представленного в 6 форматах, и облицовочной плитки из белой массы способствуют точному воспроизведению цветовых тонов, особо подчеркивая красоту мягких естественных оттенков. Коллекция Medley включает также широкий ассортимент сопутствующих изделий и декоративных элементов новых размеров, с большим разнообразием поверхностных эффектов и структурных поверхностей, что дает возможность варьировать применение и назначение материала по усмотрению проектировщика. Разнообразие изделий коллекции позволяет претворять в жизнь оригинальные проекты современных интерьеров с помощью керамики больших и малых форматов: крупноформатные плиты 75x150 из керамического гранита Supergres, классический формат 20x20 и, наконец, мелкоформатный "кирпичик" 7,5x30, отражающий гармоничное единство традиций и современного дизайна. Завершает набор форматов облицовочная плитка 25x75 из белой массы — универсальный материал, способный удовлетворить любые требования проекта. Новая коллекция Supergres является комплексным решением задач современной архитектуры. Гармоничное сочетание красок, структуры и поверхности отделки керамического материала помогает создавать мягкую обволакивающую атмосферу помещений.

—gres porcellanato

75x150 RT . 75x75 RT . 60x60 RT . 30x60 RT . 20x20 . 7,5x30

CERAMICHE
SUPERGRES

Tra formati classici e inediti dalle differenti superfici, la gamma in grès porcellanato veste gli ambienti con personalità e ricercatezza.

Between classic and brand-new sizes with different surfaces, the porcelain stoneware range adds personality and sophistication to the environments

La morbida superficie satinata del rivestimento in pasta bianca esalta la materia ceramica, contraddistinta da funzionalità e bellezza estetica.

The soft, satin surface of the white-body finish enhances the ceramic texture, giving it functionality and aesthetic beauty.

— pasta bianca

25x75

_01sugar

| Delicata eleganza,
inedita personalità.

Delicate elegance, original personality.

_02sand

| Atmosfere accoglienti,
stile essenziale.

Cozy atmospheres, essential style.

_03greige

| Personalità e carattere,
fascino e design.

Personality and character, fascination and design.

_04brown

| Tonalità calde e di tendenza
per ambienti sempre attuali.

Neutral and trendy tones for ever modern ambiances.

CERAMICHE
SUPERGRES

PORCELAIN TILE

_gres porcellanato

75x150 RT . 75x75 RT . 10mm \rightleftarrows
60x60 RT . 30x60 RT . 9,5mm \rightleftarrows **20x20** . 9mm \rightleftarrows

7,5x30 . 8,5mm \rightleftarrows

EN 14411 Allegato G_Piastrelle di ceramica pressate a secco con basso assorbimento d'acqua (E ≤ 0,5%)
Gruppo B la UGL (non smaltate, non émaille, unglasierte, unglazed, no esmaltado, Неглазурованные)

EN 14411 Allegato G_Piastrelle di ceramica pressate a secco con basso assorbimento d'acqua (E ≤ 0,5%)
Gruppo B la GL (smaltate, émaille, glasierte, glazed, esmaltado, глазурованные)

75x150RT
30'x60"

10mm \rightleftarrows

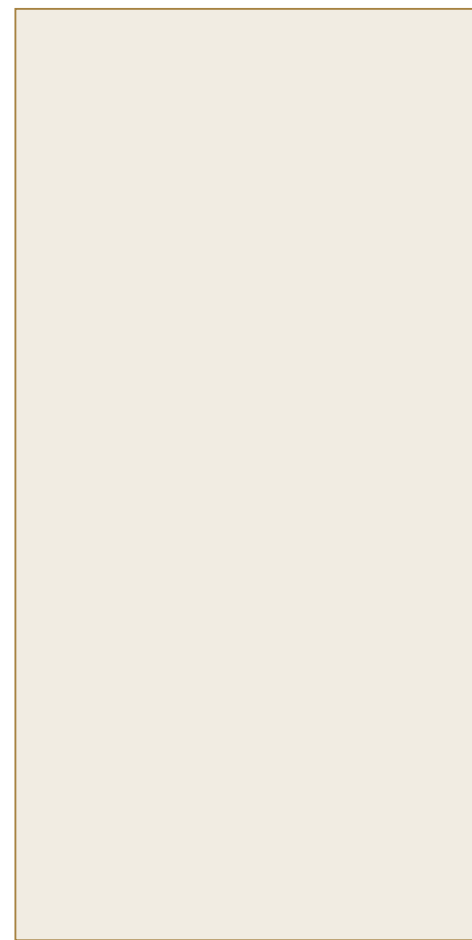

75x75RT
30'x30"

10mm \rightleftarrows

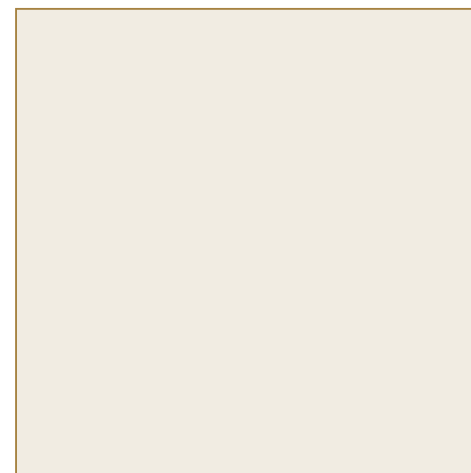

20x20
8'x8" 9mm \rightleftarrows



30x60RT
12'x24"

9,5mm \rightleftarrows

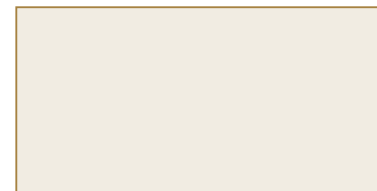

60x60RT
24'x24"

9,5mm \rightleftarrows

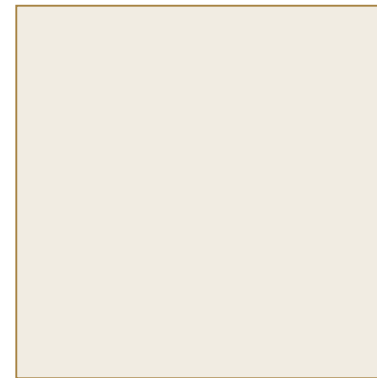

mosaico
30x30RT
12'x12"

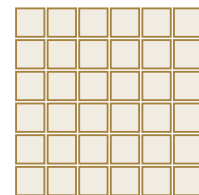

brick glossy
7,5x30
3'x12" 8,5mm \rightleftarrows



dek texture
20x20 8'x8"



WALL TILE

pasta bianca_

25x75 . 8,5mm \rightleftarrows

EN 14411 Allegato L Piastrelle di ceramica pressate a secco (E > 10 %)
Gruppo BIII GL (smaltate, émaille, glasierte, glazed, esmaltado, Глазурованные)

25x75
10'x30"

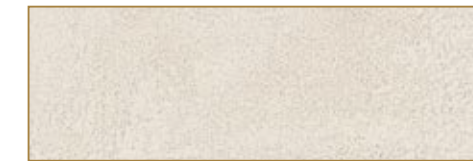

struttura block
25x75 10'x30"

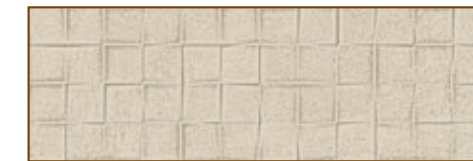

struttura mark
25x75 10'x30"



struttura mark decorata
25x75 10'x30"



campitura ramage
25x75 10'x30"



campitura origami
25x75 10'x30"

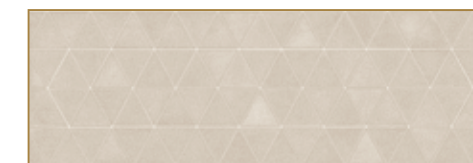

sugar01_

sand02_

greige03_

brown04_

_01sugar

_02sand

_03greige

_01 sugar

| L'eleganza incontra la funzionalità, gli spazi parlano un linguaggio fresco e contemporaneo.

Elegance merges with functionality, spaces speak a contemporary fresh language.



75x150 RT - 30"x60"



_01sugar
75x75 RT - 30"x30"

_02sand
brick glossy
7,5x30 - 3"x12"



_01sugar

25x75 - 10"x30"

campitura ramage
25x75 10"x30"

struttura mark
25x75 - 10"x30"

natural almond
19,7x120 RT - 7 3/4"x48"
serie Natural Appeal





_01sugar

25x75 - 10"x30"

campitura ramage
25x75 10"x30"

struttura mark
25x75 - 10"x30"

natural almond
19,7x120 RT - 7 3/4"x48"
serie Natural Appeal



_02sand

I nostri spazi
parlano di noi:
ogni dettaglio rivela
chi siamo.

Our spaces talk about us:
each detail reveals who we are.



75x150 RT - 30"x60"

_02sand

25x75 - 10"x30"

struttura block
25x75 10"x30"

medley dek texture
20x20 - 8"x8"





02sand

25x75 - 10"x30"

struttura block
25x75 10"x30"

medley dek texture
20x20 - 8"x8"





75x75 RT - 30"x30"

_02sand

struttura mark
25x75 - 10"x30"

medley struttura mark mix
25x75 10"x30"

natural wild strutturato
19,7x120 RT - 7 3/4"x48"
serie Natural Appeal





_02sand
75x150 RT - 30"x60"

_01sugar
brick glossy
7,5x30 - 3"x12"

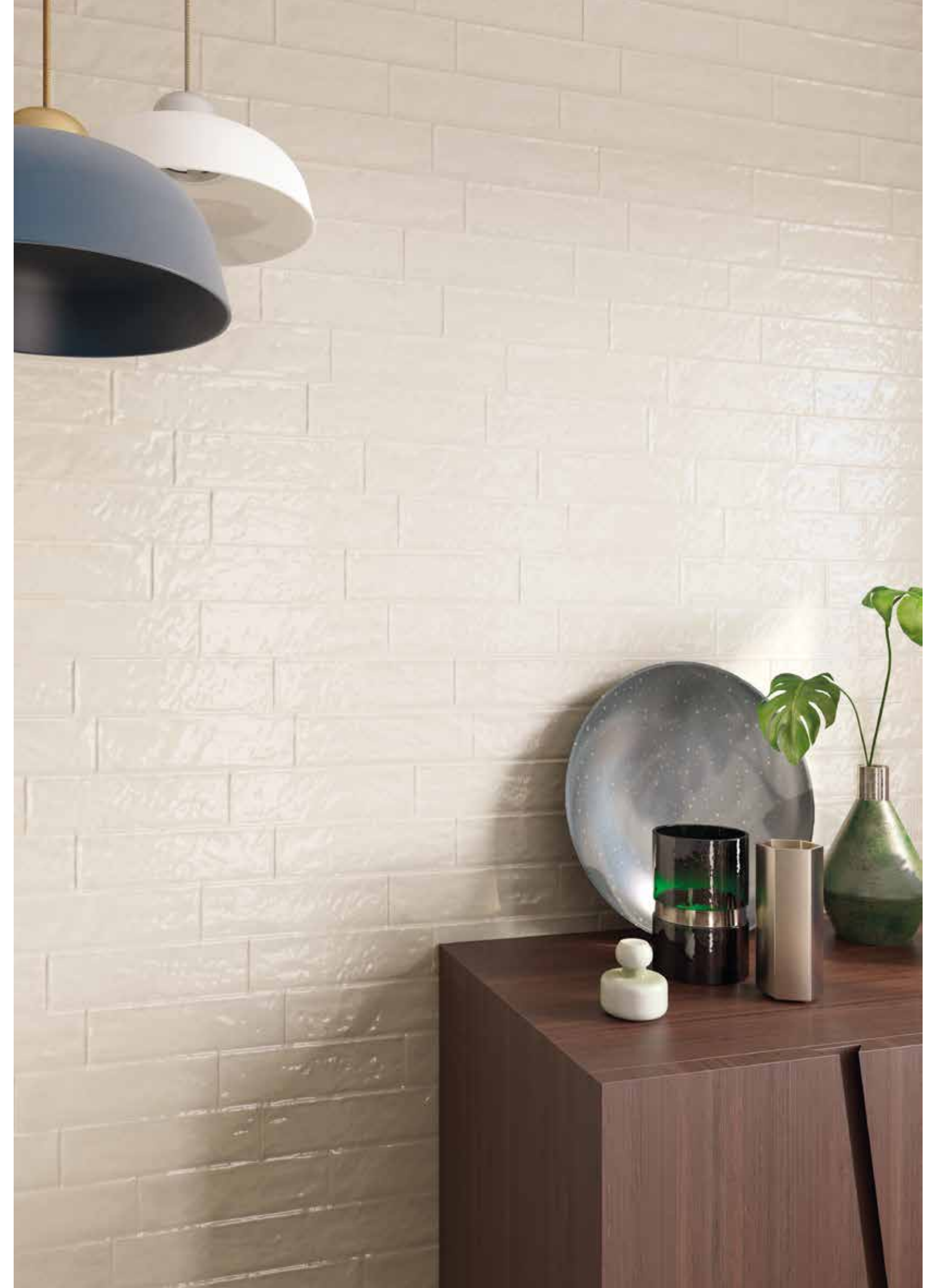

_03greige

Giochi di trame
lustrate disegnati
su materiche
superfici.

Games of polished textures
designed on materic surfaces.



75x75 RT - 30'x30"

_03greige

25x75 - 10"x30"

struttura mark
25x75 - 10"x30"

campitura origami
25x75 - 10"x30"

brick glossy
7,5x30 - 3"x12"

profilo metallo argento
0.5x100 - 0.2"x40"

75x75 RT - 30"x30"

_01sugar

25x75 - 10"x30"





_03greige

25x75 - 10"x30"

struttura mark
25x75 - 10"x30"

campitura origami
25x75 - 10"x30"

brick glossy
7,5x30 - 3"x12"

75x75 RT - 30"x30"



_03greige
75x75 RT - 30"x30"



_03greige
20x20 8"x8"

brick glossy
7,5x30 - 3"x12"

_02sand

brick glossy
7,5x30 3"x12"

_01sugar

brick glossy
7,5x30 3"x12"

profilo metallo argento
0,5x100 - 0,2"x40"





_03greige
75x150 RT - 30"x60"

_04brown
brick glossy
7,5x30 - 3"x12"



_04brown

| Tonalità calde e di tendenza per ambienti sempre attuali.

Warm and trendy tones for ever modern ambiances.



75x150 RT - 30"x60"



_04brown
75x75 RT - 30"x30"

_03greige
struttura block
25x75 - 10"x30"

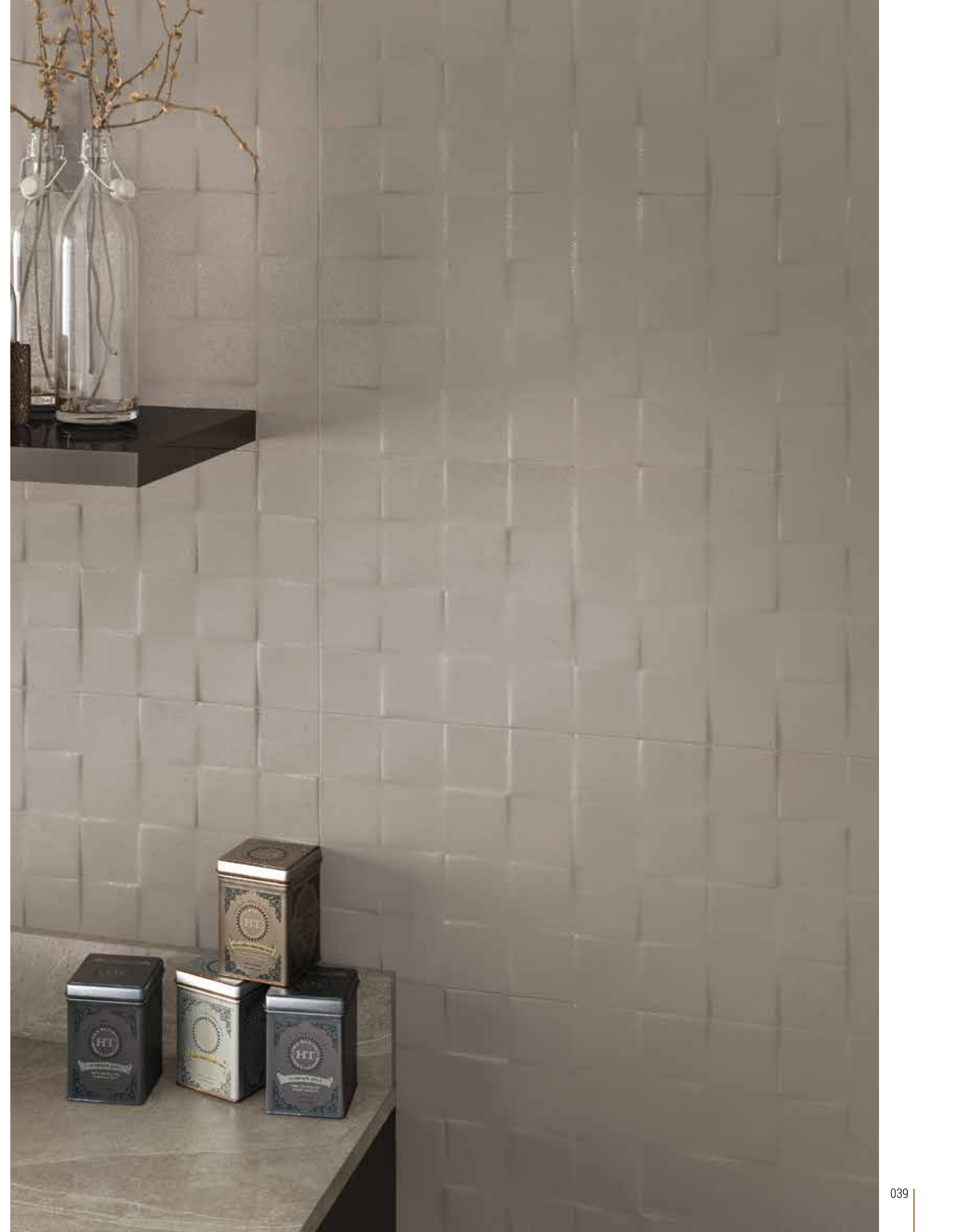

_04brown

20x20 - 8"x8"

75x150RT - 30"x60"

_01sugar

20X20 - 8"x8"



_04brown

75x150 RT - 30"x60"



—gres porcellanato

75x150 RT . 75x75 RT . 60x60 RT . 30x60 RT . 20x20 . 7,5x30

CERAMICHE
SUPERGRES



— pasta bianca

25x75

MEDLEY

75x150 RT . 75x75 RT . 10mm \pm 60x60 RT . 30x60 RT . 9,5mm \pm 20x20 . 9mm \pm 7,5x30 . 8,5mm \pm

GRES PORCELLANATO . Grès cérame . Feinsteinzeug
Porcelain stoneware . Gres porcelánico . Керамогранит

EN 14411 Allegato G. Piastrelle di ceramica pressate a secco con basso assorbimento d'acqua (E \leq 0,5%)
Gruppo B la UGL (non smaltate, non émaille, unglasierte, unglazed, no esmaltado, Неглазурованные)

EN 14411 Allegato G. Piastrelle di ceramica pressate a secco con basso assorbimento d'acqua (E \leq 0,5%)
Gruppo B la GL (smaltate, émaille, glasierte, glazed, esmaltado, глазурованные)

25x75 . 8,5mm \pm

EN 14411 Allegato L. Piastrelle di ceramica pressate a secco (E > 10 %)
Gruppo BIII GL (smaltate, émaille, glasierte, glazed, esmaltado, Глазурованные)

_01sugar



01sugar 75x150 RT - 30"x60"



01sugar 60x60 RT - 24"x24"



01sugar 75x75 RT - 30"x30"



01sugar 20x20 - 8"x8"



PEI IV

01sugar 7,5x30 - 8"x8" *

* Prodotto non indicato per pavimenti soggetti ad usura
Product not suitable for floors subject to wear

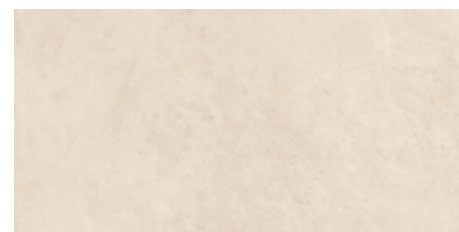

01sugar 30x60 RT - 12"x24"



01sugar Mosaico
30x30 RT - 12"x12"

Formato tessera
Mosaic size .
4.8x4.8 - 1.9"x1.9"



Medley Dek Texture
20x20 - 8"x8"

23 Soggetti diversi, formato 20x20.
L'assortimento all'interno della scatola è puramente casuale.
23 Different types of graphics, 20x20 size.
The assortment in the box is purely random.



01sugar 25x75 . 10"x30"



01sugar struttura Block 25x75 . 10"x30"



01sugar struttura Mark 25x75 . 10"x30"



Medley struttura Mark Dek mix 25x75 . 10"x30"



01sugar campitura Ramage 25x75 . 10"x30"



01sugar / 02sand campitura Origami 25x75 . 10"x30"

MEDLEY

75x150 RT . 75x75 RT . 10mm \pm 60x60 RT . 30x60 RT . 9,5mm \pm 20x20 . 9mm \pm 7,5x30 . 8,5mm \pm

GRES PORCELLANATO . Grès cérame . Feinsteinzeug
Porcelain stoneware . Gres porcelánico . Керамогранит

EN 14411 Allegato G. Piastrelle di ceramica pressate a secco con basso assorbimento d'acqua (E \leq 0,5%)
Gruppo B la UGL (non smaltate, non émaille, unglasierte, unglazed, no esmaltado, Неглазурованные)

EN 14411 Allegato G. Piastrelle di ceramica pressate a secco con basso assorbimento d'acqua (E \leq 0,5%)
Gruppo B la GL (smaltate, émaille, glasierte, glazed, esmaltado, глазурованные)

25x75 . 8,5mm \pm

EN 14411 Allegato L. Piastrelle di ceramica pressate a secco (E > 10 %)
Gruppo BIII GL (smaltate, émaille, glasierte, glazed, esmaltado, Глазурованные)

_02sand



02sand 75x150 RT - 30"x60"



02sand 60x60 RT - 24"x24"



02sand 75x75 RT - 30"x30"



02sand 20x20 - 8"x8"



PEI IV

02sand 7,5x30 - 8"x8" *

* Prodotto non indicato per pavimenti soggetti ad usura
Product not suitable for floors subject to wear



02sand 30x60 RT - 12"x24"



02sand Mosaico
30x30 RT - 12"x12"

Formato tessera
Mosaic size .
4.8x4.8 - 1.9"x1.9"



Medley Dek Texture
20x20 - 8"x8"

23 Soggetti diversi, formato 20x20.
L'assortimento all'interno della scatola è puramente casuale.
23 Different types of graphics, 20x20 size.
The assortment in the box is purely random.



02sand 25x75 . 10"x30"



02sand struttura Block 25x75 . 10"x30"



02sand struttura Mark 25x75 . 10"x30"



Medley struttura Mark Dek mix 25x75 . 10"x30"



02sand campitura Ramage 25x75 . 10"x30"



01sugar / 02sand campitura Origami 25x75 . 10"x30"

MEDLEY

75x150 RT . 75x75 RT . 10mm \pm 60x60 RT . 30x60 RT . 9,5mm \pm 20x20 . 9mm \pm 7,5x30 . 8,5mm \pm

GRES PORCELLANATO . Grès cérame . Feinsteinzeug
Porcelain stoneware . Gres porcelánico . Керамогранит

EN 14411 Allegato G. Piastrelle di ceramica pressate a secco con basso assorbimento d'acqua (E ≤ 0,5%)
Gruppo B la UGL (non smaltate, non émaille, unglasierte, unglazed, no esmaltado, Неглазурованные)

EN 14411 Allegato G. Piastrelle di ceramica pressate a secco con basso assorbimento d'acqua (E ≤ 0,5%)
Gruppo B la GL (smaltate, émaille, glasierte, glazed, esmaltado, глазурованные)

25x75 . 8,5mm \pm

EN 14411 Allegato L. Piastrelle di ceramica pressate a secco (E > 10 %)
Gruppo BIII GL (smaltate, émaille, glasierte, glazed, esmaltado, Глазурованные)

_03greige



03greige 75x150 RT - 30"x60"



03greige 60x60 RT - 24"x24"



03greige 75x75 RT - 30"x30"



03greige 20x20 - 8"x8"



03greige 7,5x30 - 8"x8" *

* Prodotto non indicato per pavimenti soggetti ad usura
Product not suitable for floors subject to wear



03greige 30x60 RT - 12"x24"



03greige Mosaico
30x30 RT - 12"x12"

Formato tessera
Mosaic size
4.8x4.8 - 1.9"x1.9"

PEI III



Medley Dek Texture
20x20 - 8"x8"

23 Soggetti diversi, formato 20x20.
L'assortimento all'interno della scatola è puramente casuale.
23 Different types of graphics, 20x20 size.
The assortment in the box is purely random.



03greige 25x75 . 10"x30"



03greige struttura Block 25x75 . 10"x30"



03greige struttura Mark 25x75 . 10"x30"



Medley struttura Mark Dek mix 25x75 . 10"x30"



03greige campitura Ramage 25x75 . 10"x30"



03greige campitura Origami 25x75 . 10"x30"

MEDLEY

75x150 RT . 75x75 RT . 10mm \pm 60x60 RT . 30x60 RT . 9,5mm \pm 20x20 . 9mm \pm 7,5x30 . 8,5mm \pm

GRES PORCELLANATO . Grès cérame . Feinsteinzeug
Porcelain stoneware . Gres porcelánico . Керамогранит

EN 14411 Allegato G . Piastrelle di ceramica pressate a secco con basso assorbimento d'acqua (E \leq 0,5%)
Gruppo B la UGL (non smaltate, non émaille, unglasierte, unglazed, no esmaltado, Неглазурованные)

EN 14411 Allegato G . Piastrelle di ceramica pressate a secco con basso assorbimento d'acqua (E \leq 0,5%)
Gruppo B la GL (smaltate, émaille, glasierte, glazed, esmaltado, глазурованные)

_04brown



04brown 75x150 RT - 30"x60"



04brown 60x60 RT - 24"x24"



04brown 75x75 RT - 30"x30"



04brown 20x20 - 8"x8"



PEI II

04brown 7,5x30 - 8"x8" *

* Prodotto non indicato per pavimenti soggetti ad usura
Product not suitable for floors subject to wear



04brown 30x60 RT - 12"x24"



04brown Mosaico
30x30 RT - 12"x12"

Formato tessera
Mosaic size .
4.8x4.8 - 1.9"x1.9"



Medley Dek Texture
20x20 - 8"x8"

23 Soggetti diversi, formato 20x20.
L'assortimento all'interno della scatola è puramente casuale.
23 Different types of graphics, 20x20 size.
The assortment in the box is purely random.

MEDLEY

75x150 RT . 75x75 RT . 10mm ⇄ 60x60 RT . 30x60 RT . 9,5mm ⇄ 20x20 . 9mm ⇄ 7,5x30 . 8,5mm ⇄

GRES PORCELLANATO . Grès cérame . Feinsteinzeug
Porcelain stoneware . Gres porcelánico . Керамогранит

EN 14411 Allegato G. Piastrelle di ceramica pressate a secco con basso assorbimento d'acqua (E ≤ 0,5%)
Gruppo B la UGL (non smaltate, non émaille, unglasierte, unglazed, no esmaltado, Неглазурованные)

EN 14411 Allegato G. Piastrelle di ceramica pressate a secco con basso assorbimento d'acqua (E ≤ 0,5%)
Gruppo B la GL (smaltate, émaille, glasierte, glazed, esmaltado, Глазурованные)

PEZZI SPECIALI . Trims . Pièces Spéciales . Formstücke . Специальные изделия

GRES PORCELLANATO . Grès cérame . Feinsteinzeug
Porcelain stoneware . Gres porcelánico . Керамогранит

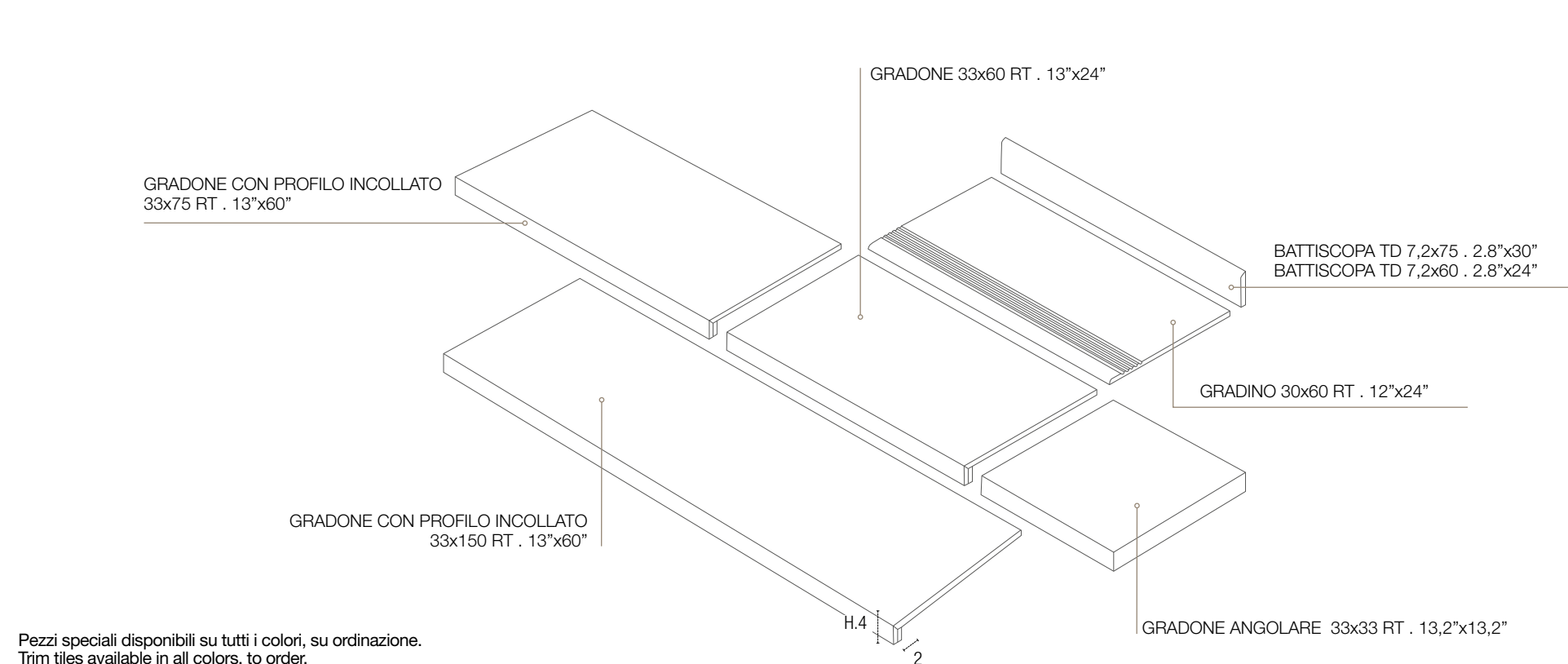

Pezzi speciali disponibili su tutti i colori, su ordinazione.
Trim tiles available in all colors, to order.
Pièces spéciales disponibles dans toutes les couleurs, sur demande.
Formteile auf Bestellung in allen Farben verfügbar.
Piezas especiales disponibles en todos los colores por encargo.
Специальные элементы доступны для всех цветов по запросу.

AVVERTENZE PER LA POSA . RECOMMENDATIONS FOR INSTALLATION .

Recommandations pour la pose . Verlegetipps . Advertencias de colocación . Рекомендации по укладке

Per la posa del materiale rettificato si consiglia una fuga minima di 2 mm.

As for rectified materials, it is strongly recommended a minimum of 2 mm joint.

Pour poser du matériel rectifié nous vous conseillons un joint minimum de 2 mm.

Für die Verlegung des kalibrierten Material empfehlen wir einen Mindestfuge von 2 mm.

Para la colocación de material rectificado se aconsejan juntas minima de 2 mm.

Ретифицированную плитку рекомендуется укладывать со швом 2 мм.

75x150 RT . 75x75 RT . 10mm ⇄ 60x60 RT . 30x60 RT . 9,5mm ⇄ 20x20 . 9mm ⇄ 7,5x30 . 8,5mm ⇄

GRES PORCELLANATO . Grès cérame . Feinsteinzeug
Porcelain stoneware . Gres porcelánico . Керамогранит

EN 14411 Allegato G. Piastrelle di ceramica pressate a secco con basso assorbimento d'acqua (E ≤ 0,5%)
Gruppo B la UGL (non smaltate, non émaille, unglasierte, unglazed, no esmaltado, Неглазурованные)

EN 14411 Allegato G. Piastrelle di ceramica pressate a secco con basso assorbimento d'acqua (E ≤ 0,5%)
Gruppo B la GL (smaltate, émaille, glasierte, glazed, esmaltado, Глазурованные)

IMBALLAGGI . Emballage . Verpackung . Packing . Embalaje . Verpackung . Упаковка

	pz/box	mq/box	kg/box	box/plt	mq/plt	kg/plt	spessore
75x150 RT	1	1,125	25,5	25	28,13	650	10 mm
75x75 RT	2	1,125	25,95	42	47,25	1105	10 mm
60x60 RT	3	1,08	23	40	43,2	932	9,5 mm
30x60 RT	6	1,08	23,4	40	43,2	948	9,5 mm
20x20	30	1,20	23,9	56	67,2	1350	9 mm
7,5x30	48	1,08	19,50	48	51,84	951	8,5mm
30x30 RT mosaico su rete	10	0,9	17,00	30	27,00	525	
0,5x100 profilo metallo	3	-	-	-	-	-	8 mm
battiscopa 7,2x75 TD	10	7,50 ml	11,00	63	472,50 ml	673	
battiscopa 7,2x60 TD	10	6,00 ml	9,40	70	420 ml	673	
33x150 RT gradone c/profilo incollato	2	-	-	-	-	-	
33x75 RT gradone c/profilo incollato	2	-	-	-	-	-	
33x60 RT gradone c/profilo incollato	4	-	-	-	-	-	
33x33 RT angolare gradone c/prof.inc.	4	-	-	-	-	-	
30x60 RT gradino	6	-	-	-	-	-	

25x75 RT . 8,5mm ⇄

EN 14411 Allegato L. Piastrelle di ceramica pressate a secco (E > 10 %)
Gruppo B III GL (smaltate, émaille, glasierte, glazed, esmaltado, Глазурованные)

	pz/box	mq/box	kg/box	box/plt	mq/plt	kg/plt	spessore
25x75	6	1,13	17,00	54	60,75	930	8,5 mm
25x75 struttura mark	5	0,94	14,00	54	50,63	768	8,5 mm*
25x75 struttura mark decorata	5	0,94	14,00	54	50,63	768	8,5 mm*
25x75 struttura block	5	0,94	14,00	54	50,63	768	8,5 mm*
25x75 campitura ramage	4	-	-	-	-	-	
25x75 campitura origami	4	-	-	-	-	-	
0,5x100 profilo metallo	3	-	-	-	-	-	8 mm

* Spessore riferito al fondo liscio equivalente

Thickness refers to the equivalent smooth background

Épaisseur se rapportant au carreau lisse équivalent

Die Stärke bezieht sich auf die entsprechende glatte Grundfliese.

Espesor referido al fondo liso equivalente

Толщина эквивалентной плитки с гладким основанием

**GRES PORCELLANATO . Grès cérame . Feinsteinzeug
Porcelain stoneware . Gres porcelánico . Керамогранит**

Norma di riferimento: EN 14411 (ISO 13006) Allegato G - Piastrelle di ceramica pressate a secco con basso assorbimento d'acqua (Ev ≤ 0,5%)
 Norme retenue: EN 14411 (ISO 13006) Annexe G - Carreaux céramiques pressés à sec avec faible absorption d'eau (Ev ≤ 0,5%) . Besuzgnorm: EN 14411 (ISO 13006) Anlage G - Trockengepresste keramische Fliesen und Platten mit niedriger Wasseraufnahme (Ev ≤ 0,5%) . Reference standard: EN 14411 (ISO 13006) Appendix G - Dry pressed ceramic tiles with low water absorption (Ev ≤ 0,5%) . Norma de referencia: EN 14411 (ISO 13006) Anexo G - Baldosas de cerámica prensadas en seco (Ev ≤ 0,5%) . Соответствует норме EN 14411 (ISO 13006) Керамические плитки, спрессованные всухую, с низким водопоглощением (Ev ≤ 0,5%)



GRUPPO B Ia

CARATTERISTICHE TECNICHE . TECHNICAL CHARACTERISTICS Características técnicas . Technische eigenschaften Características técnicas . Технические характеристики	NORMA . NORMS Normes . Normen Normas . Стандарт	REQUISITI RICHIESTI . REQUIREMENTS Conditions requisés . Geforderte eigenschaften Valor solicitud . Значение, требуемое в соответствии с нормами			VALORE MEDIO SUPERGRES * Valeur moyenne . Average rating Durchschnittswert . среднее значение	
		SUPERFICIE NATURALE		SUPERFICIE GLOSSY		
Lunghezza e larghezza dei lati . Lenght and width of the sides Longuer et largeur de côtés . Länge und Breite Largo y ancho de los lados . Размеры сторон	ISO 10545-2	RETTIFICATI	± 0,4 mm	± 0,3 %	± 1,0 mm	Conforme . According to Conforme . Gemäss Conforme . Соответствует
Rettilineità degli spigoli . Straightness Equerrage des angles . Kantengeradheit Rectilineidad de las aristas . Кривизна сторон			± 0,4 mm	± 0,3 %	± 0,8 mm	Conforme . According to Conforme . Gemäss Conforme . Соответствует
Ortogonalità** . Rectangularity** Orthogonalité . Rechtwinkligkeit Ortogonalidad . Косоугольность			± 0,4 mm	± 0,3 %	± 1,5 mm	Conforme . According to Conforme . Gemäss Conforme . Соответствует
Planarità . Flatness Planéité . Planität Planaridad . Кривизна лицевой поверхности			± 0,6 mm	± 0,4 %	± 1,8 mm	Conforme . According to Conforme . Gemäss Conforme . Соответствует
Lunghezza e larghezza dei lati . Lenght and width of the sides Longuer et largeur de côtés . Länge und Breite Largo y ancho de los lados . Размеры сторон	ISO 10545-2	NON RETTIFICATI	± 0,9 mm	± 0,6 %	± 2,0 mm	Conforme . According to Conforme . Gemäss Conforme . Соответствует
Rettilineità degli spigoli . Straightness Equerrage des angles . Kantengeradheit Rectilineidad de las aristas . Кривизна сторон			± 0,8 mm	± 0,5 %	± 1,5 mm	Conforme . According to Conforme . Gemäss Conforme . Соответствует
Ortogonalità** . Rectangularity** Orthogonalité . Rechtwinkligkeit Ortogonalidad . Косоугольность			± 0,8 mm	± 0,5 %	± 2,0 mm	Conforme . According to Conforme . Gemäss Conforme . Соответствует
Planarità . Flatness Planéité . Planität Planaridad . Кривизна лицевой поверхности			± 0,8 mm	± 0,5 %	± 2,0 mm	Conforme . According to Conforme . Gemäss Conforme . Соответствует
Spessore . Thickness Epaisseur . Stärke Espesor . Толщина	ISO 10545-2		± 0,5 mm	± 5 %	± 0,5 mm	Conforme . According to Conforme . Gemäss Conforme . Соответствует
Assorbimento % d'acqua . Water absorption Absorption d'eau . Wasseraufnahme Absorción % de agua . Водопоглощение	ISO 10545-3		Ev ≤ 0,5%			Conforme . According to Conforme . Gemäss Conforme . Соответствует
Determinazione della resistenza a flessione e della forza di rottura Flexion and break resistance Résistance à la flexion et à la force de rupture Biegefestigkeit und Bruchlast Resistencia a la flexión y carga de rotura Предел прочности при изгибе и разрушающая нагрузка	ISO 10545-4		Spessore ≥ 7,5 mm	$\left[\begin{array}{l} S \geq 1300 \\ R \geq 35 \text{ N/mm}^2 \end{array} \right.$		Conforme . According to Conforme . Gemäss Conforme . Соответствует
Determinazione della resistenza all'abrasione profonda (porcellanato non smaltato) UGL Deep Scratch Resistance (unglazed porcelain) UGL Résistance à l'abrasion profonde (grès cérame) UGL Tiefenverschleissbeständigkeit (unglasierte Feinsteinzeug) UGL Resistencia a la abrasión profunda (no esmaltados) UGL Стойкость к абразиву (UGL)	ISO 10545-6		≤ 175 mm ³			Conforme . According to Conforme . Gemäss Conforme . Соответствует
Determinazione della resistenza all'abrasione superficiale PEI (porcellanato smaltato) GL Surface abrasion resistance PEI (glazed porcelain) GL Résistance à l'abrasion superficielle PEI (grès cérame émaillé) GL Beständigkeit gegen Abrieb PEI (glasierte Feinsteinzeug) GL Resistencia a la abrasión superficial PEI (esmaltados) GL Поверхностная износостойкость PEI (глазурованный керамогранит) GL	ISO 10545-7		Classificazione PEI . Classification PEI Classification PEI . Klassifizierung PEI Evaluación PEI . Классификация PEI		Vedere dettaglio . See chart Voir liste . Siehe tab. Como indicado . См. детали	
Coefficiente di espansione termica lineare tra 20° e 100° C Linear thermal expansion 20°C to 100°C Dilatation thermique linéaire entre 20°C et 100°C Lineare Wärmeausdehnung zwischen 20°C und 100°C Coeficiente de expansión térmica lineal entre 20°C y 100°C Коэффициент линейного теплового расширения	ISO 10545-8		Metodo di prova disponibile . Test method available Méthode d'essai disponible . Prüfverfahren verfügbar Método disponible . Используемый метод испытания		Conforme . According to Conforme . Gemäss Conforme . Соответствует	
Resistenza agli sbalzi termici . Thermal shock resistance Résistance aux écarts de température . Temperaturwechselbeständigkeit Resistencia a los choques térmicos . Стойкость к перепаду температур	ISO 10545-9		Metodo di prova disponibile . Test method available Méthode d'essai disponible . Prüfverfahren verfügbar Método disponible . Используемый метод испытания		Conforme . According to Conforme . Gemäss Conforme . Соответствует	
Resistenza al gelo . Frost resistance Résistance au gel . Frostbeständigkeit Resistencia al hielo . Морозоустойчивость	ISO 10545-12		Metodo di prova disponibile . Test method available Méthode d'essai disponible . Prüfverfahren verfügbar Método disponible . Используемый метод испытания		Conforme . According to Conforme . Gemäss Conforme . Соответствует	
Determinazione della resistenza chimica . Chemical resistance Résistance chimique . Chemikalienbeständigkeit Resistencia a los productos químicos . Химическая стойкость	ISO 10545-13		Classe UB minimo (UGL) - GB minimo (GL) Classe UB min (UGL) - GB min (GL) Categorie UB min (UGL) - GB min (GL) Klasse UB min (UGL) - GB min (GL) Минимум класс UB (UGL) - GB min. (GL)		Conforme . According to Conforme . Gemäss Conforme . Соответствует	
Determinazione della resistenza alle macchie . Resistance to staining Résistance aux taches . Beständigkeit gegen Fleckenbil Resistencia a las manchas . Устойчивость эмали к загрязнению	ISO 10545-14		Classe 3 minimo . Class 3 min Classe 3 min . Kategorie 3 min Klasse 3 min . Минимум 3 класс		Conforme . According to Conforme . Gemäss Conforme . Соответствует	
Resistenza allo scivolamento . Slip resistance Résistance au glissement . Bestimmung der Rutschermungsfähigkeit Antideslizamiento . Сопротивление скольжению	DIN 51130		Classificazione R . Classification R Evaluación R . Classification R Klassifizierung R . Классификация R		R9	
Resistenza allo scivolamento - coefficiente di attrito dinamico (DCOF) Slip resistance - dynamic friction coefficient Résistance au glissement - résistance de frottement dynamique Bestimmung der Rutschermungsfähigkeit - dynamischer Reibungskoeffizient Resistencia al deslizamiento - coeficiente de rozamiento dinámico Сопротивление скольжению . Коэффициент трения	BOT 3000 STANDARD ANSI A137.1:2012		≥ 0,42 wet		Conforme . According to Conforme . Gemäss Conforme . Соответствует	

GRADO DI VARIAZIONE CROMATICA Ogni prodotto si caratterizza per un grado di stonalizzazione variabile da prodotto a prodotto, dacolore a colore. Per stonalizzazione s'intende variazione di gradazione cromatica da piastrella a piastrella.
CLOUR SHADE VARIATION Every product is characterised by colour-shading that can vary from one product to another and from one colour to another. When referring to colour-shading we refer to the chromatic variation of the tile surface.



RIVESTIMENTO IN PASTA BIANCA
White body wall tiles - revêtements en pâte blanche - weißscherbiger wandfliesen - Revestimientos en pasta blanca - настенная плитка на белой глине

Norma di riferimento: EN 14411 (ISO 13006) Allegato L Piastrelle di ceramica pressate a secco (Ev > 10 %)
 Reference standard: EN 14411 (ISO 13006) Appendix L Dry pressed ceramic tiles (Ev > 10 %) . Norme retenue: EN 14411 (ISO 13006) Annexe L Carreaux céramiques pressés à sec (Ev > 10 %) . Besuzgnorm: EN 14411 (ISO 13006) Anlage L Trockengepresste keramische Fliesen und Platten (Ev > 10 %) . Norma de referencia: EN 14411 (ISO 13006) Anexo L Baldosas de cerámica prensadas en seco (Ev > 10 %) . Соответствует норме EN 14411 (ISO 13006) Приложение L Керамические плитки, полученные путём прессования (водопоглощение Ev > 10%)



GRUPPO B III GL

CARATTERISTICHE TECNICHE . TECHNICAL CHARACTERISTICS Características técnicas . Technische eigenschaften Características técnicas . Технические характеристики	NORMA . NORMS Normes . Normen Normas . Стандарт	REQUISITI RICHIESTI . REQUIREMENTS Conditions requisés . Geforderte eigenschaften Valor solicitud . Значение, требуемое в соответствии с нормами			VALORE MEDIO SUPERGRES * Valeur moyenne . Average rating Durchschnittswert . среднее значение	
		Lunghezza e larghezza dei lati . Lenght and width of the sides Longuer et largeur de côtés . Länge und Breite Largo y ancho de los lados . Размеры сторон	ISO 10545-2	NON RETTIFICATI	± 0,9 mm	± 0,6 %
Rettilineità degli spigoli . Straightness Equerrage des angles . Kantengeradheit Rectilineidad de las aristas . Кривизна сторон	± 0,8 mm	± 0,5 %			± 1,5 mm	Conforme . According to Conforme . Gemäss Conforme . Соответствует
Ortogonalità** . Rectangularity** Orthogonalité . Rechtwinkligkeit Ortogonalidad . Косоугольность	± 0,8 mm	± 0,5 %			± 2,0 mm	Conforme . According to Conforme . Gemäss Conforme . Соответствует
Planarità . Flatness Planéité . Planität Planaridad . Кривизна лицевой поверхности	± 0,8 mm	± 0,5 %			± 2,0 mm	Conforme . According to Conforme . Gemäss Conforme . Соответствует
Spessore . Thickness Epaisseur . Stärke Espesor . Толщина	ISO 10545-2		± 0,5 mm	± 10 %	± 0,5 mm	Conforme . According to Conforme . Gemäss Conforme . Соответствует
Assorbimento % d'acqua . Water absorption Absorption d'eau . Wasseraufnahme Absorción % de agua . Водопоглощение	ISO 10545-3		Ev ≥ 10%			Conforme . According to Conforme . Gemäss Conforme . Соответствует
Determinazione della resistenza a flessione e della forza di rottura Flexion and break resistance Résistance à la flexion et à la force de rupture Biegefestigkeit und Bruchlast Resistencia a la flexión y carga de rotura Предел прочности при изгибе и разрушающая нагрузка	ISO 10545-4		Spessore ≥ 7,5 mm	$\left[\begin{array}{l} S \geq 600 \\ R \geq 15 \text{ N/mm}^2 \end{array} \right.$		Conforme . According to Conforme . Gemäss Conforme . Соответствует
Determinazione della resistenza al cavillo Crazing resistance Résistance aux craquelures Haariß-Beständigkeit Resistencia al cuarteado Устойчивость эмали к кракелюру (старению)	ISO 10545-11		Richiesta . Required Requise . Erforderlich Exigida . Согласно норме			Conforme . According to Conforme . Gemäss Conforme . Соответствует
Determinazione della resistenza chimica . Chemical resistance Résistance chimique . Chemikalienbeständigkeit Resistencia a los productos químicos . Химическая стойкость	ISO 10545-13		GB minimo (GL) GB min (GL) GB min (GL) GB min (GL) GB min. (GL)			Conforme . According to Conforme . Gemäss Conforme . Соответствует
Determinazione della resistenza alle macchie . Resistance to staining Résistance aux taches . Beständigkeit gegen Fleckenbil Resistencia a las manchas . Устойчивость эмали к загрязнению	ISO 10545-14		Classe 3 minimo . Class 3 min Classe 3 min . Kategorie 3 min Klasse 3 min . Минимум 3 класс			Conforme . According to Conforme . Gemäss Conforme . Соответствует
Determinazione della resistenza alle macchie . Resistance to staining Résistance aux taches . Beständigkeit gegen Fleckenbil Resistencia a las manchas . Устойчивость эмали к загрязнению	ISO 10545-14		Classe 3 minimo . Class 3 min Classe 3 min . Kategorie 3 min Klasse 3 min . Минимум 3 класс			Conforme . According to Conforme . Gemäss Conforme . Соответствует

*** Valori riferiti ai fondi. Le caratteristiche tecniche fanno riferimento al formato nominale delle piastrelle espresso in mm.**

These values refer to the bottoms. The technical characteristics refer to the nominal size of tiles expressed in mm
 Valeurs se référant aux fonds. Les caractéristiques techniques se réfèrent au format nominal des carreaux exprimé en mm.
 Werte bezogen auf Grundfliesen. Die Angaben beziehen sich auf die Nenngroße der Fliesen in mm. .
 Valores referidos a los fondos. Las características técnicas se refieren al formato nominal de las baldosas expresado en mm.
 Показатели относятся к фоновой плитке. Технические характеристики относятся к номинальному формату плиток, выраженному в мм.

Se non indicato diversamente, i valori delle prove tecniche si riferiscono alla superficie naturale.

Unless otherwise indicated, the values of technical tests refer to the natural surface finish.
 Sauf indication contraire, les valeurs des tests techniques se rapportent à la surface naturelle.
 Wenn nicht anders angegeben beziehen sich die Werte der technischen Tests auf die natürliche Oberfläche.
 Los valores de las pruebas técnicas se refieren a la superficie natural (si no es indicada una situación diferente).
 Если не указано иное, результаты испытаний относятся к натуральной поверхности.

**** Per piastrelle rettangolari che abbiano il lato maggiore L ≥ 60 cm, e rapporto tra i lati ≥ 3, la misurazione dell'ortogonalità deve venire condotta solo sul lato corto.**

For rectangular tiles with longest side L ≥ 60 cm and a ratio length/width L/W ≥ 3, the measurement of orthogonality should only be carried out on short edges.
 Pour les carreaux rectangulaires qui ont le côté le plus long L ≥ 60 cm, et le rapport entre les côtés ≥ 3, la mesure de l'orthogonalité se fait seulement sur le côté le plus court.
 Bei rechteckigen Fliesen, mit der längsten Seite L ≥ 60 cm und einem Seitenverhältnis von ≥ 3 darf die Messung der Rechteckigkeit nur an der kurzen Seite durchgeführt werden.
 Para las baldosas rectangulares con lado mayor L ≥ 60 cm y proporción entre los lados ≥ 3, la medición de ortogonalidad tiene que ser efectuada sólo en el lado corto.
 Для прямоугольных плиток с более длинной гранью L ≥ 60 см и соотношением граней ≥ 3 измерение ортогональности выполняется только по короткой грани.

I dati e le informazioni riportate nel presente catalogo sono aggiornate al momento della stampa e potrebbero subire successive correzioni e/o modifiche. Verificare sempre l'ultima edizione disponibile confrontando la data riportata nell'ultima pagina della versione cartacea, con quella indicata nel pdf del catalogo scaricabile dal sito **www.supergres.com**

I colori e le caratteristiche estetiche dei prodotti sono indicativi e si avvicinano quanto più possibile a quelli reali nei limiti consentiti dai processi di stampa.

Data and information reported in this catalogue are updated at the moment of catalogue printing therefore they may be subject to subsequent corrections and/or amendments. Always check the latest available issue and compare the date reported on the last page of the hard-paper copy of the catalogue with that stated in the pdf. format downloadable on website **www.supergres.com**

The colours and aesthetic features of products are indicative and reproduce, as close as possible, the real colours and features taking into consideration the restrictions of printing processes.

© Copyright 2017 Ceramiche Supergres Casalgrande (Reggio Emilia) - Italy
Pubblicato da Ceramiche Supergres. Strada Statale 467, n° 34 - 42013 Casalgrande (RE) Italy
Aprile 2017
Progetto, direzione e coordinamento a cura dell'ufficio marketing Ceramiche Supergres

© Copyright 2017 by Ceramiche Supergres Casalgrande (Reggio Emilia) - Italy
Published by Ceramiche Supergres. Strada Statale 467, n° 34 - 42013 Casalgrande (RE) Italy
April 2017
Project, management and co-ordination by marketing Ceramiche Supergres

CERAMICHE SUPERGRES

Finito di stampare a Reggio Emilia (RE) nel mese di Settembre 2017 da Grafiche Pioppi per conto di Ceramiche Supergres
Strada Statale 467, n° 34 - 42013 Casalgrande (RE) Italy.

I prodotti, i marchi e le immagini riprodotte nel presente catalogo sono tutelati ai sensi della normativa vigente in materia di proprietà intellettuale.
Ogni violazione degli stessi verrà perseguita a norma di legge.

Printed in Reggio Emilia (RE) in the month of September 2017 by Grafiche Pioppi on behalf of Ceramiche Supergres
Strada Statale 467, n° 34 - 42013 Casalgrande (RE) Italy

All products, trade-marks and photographs reproduced in this catalogue are subject to all existing intellectual property laws.
Any breach thereof will be dealt with under the provisions provided by such law.

CERAMICHE
SUPERGRES

Office: Strada Statale 467, 34
42013 Casalgrande (RE) Italy
Ph. +39 0522 997411
Fax Export +39 0522 997415
Fax Italia +39 0522 997494

Warehouse: Via dell'Industria, 1 - Villaggio Macina
42013 Salvaterra di Casalgrande (RE) Italy

info@supergres.com . www.supergres.com