

Distribuitor în România – Gada Ceramic București, Str. Vlad Județu 48  
Website: [www.gadaceramic.ro](http://www.gadaceramic.ro)

# PURITY of MARBLE

A TIMELESS MARBLE COLLECTION FOR CONTEMPORARY SPACES

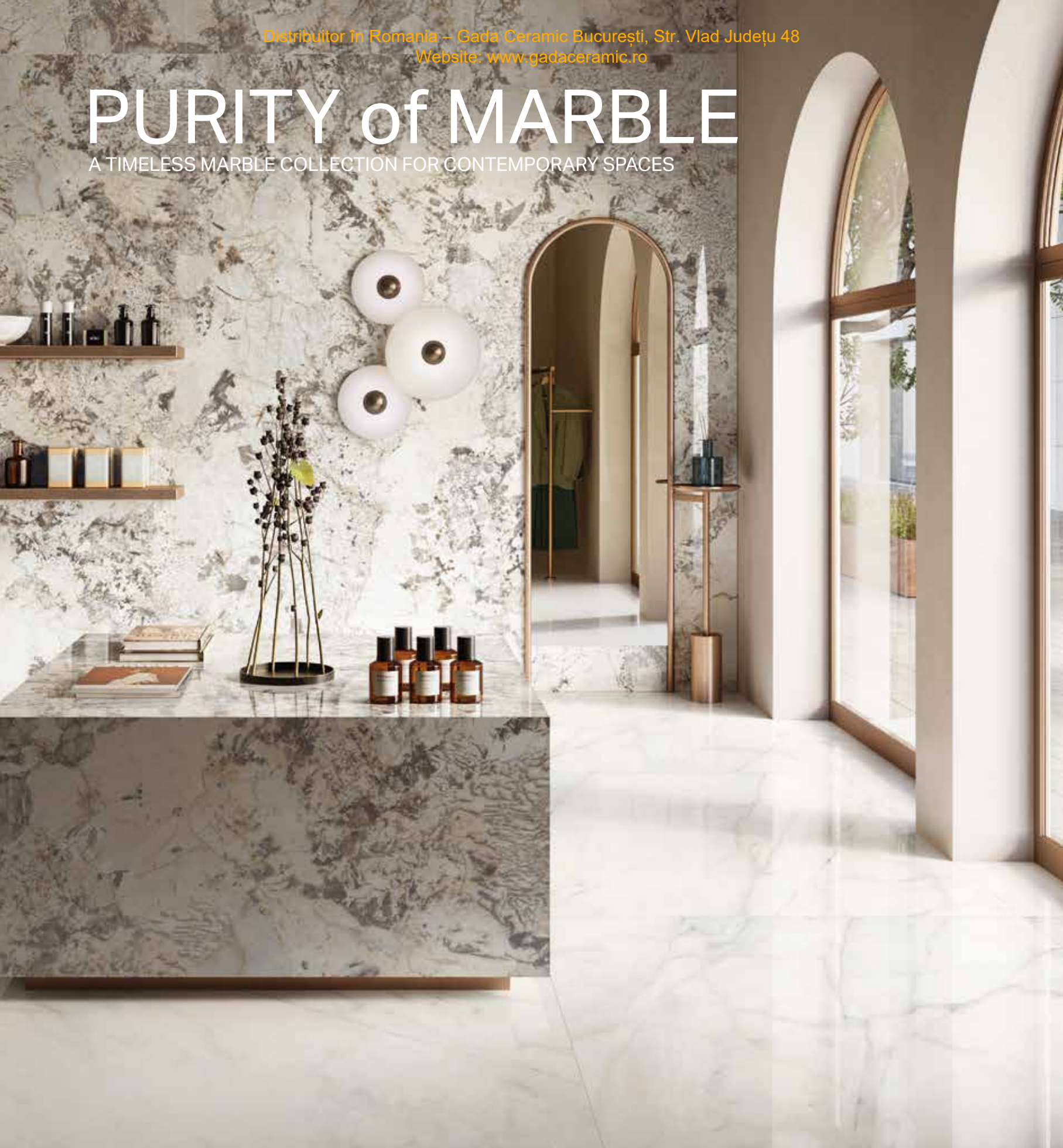

CERAMICHE  
SUPERGRES

# PURITY OF MARBLE

The project .....	2
The range .....	4
Image gallery .....	15
Product gallery .....	119
Vein matching .....	132
Summary table .....	138
Technical information .....	140

# La purezza e l'eleganza del marmo

The purity and elegance of marble.  
La pureté et l'élégance du marbre.  
Die Reinheit und Eleganz von Marmor.

**20** colours,  
**2** technologies,  
**3** finish,  
**6** sizes,  
**27** large slabs,  
**20** vein matching

La nobiltà del marmo e la raffinatezza delle venature cromatiche trovano un perfetto punto d'incontro in Purity of Marble. Un progetto completo in gres porcellanato e rivestimenti in pasta bianca che interpreta in chiave ceramica l'eleganza e la bellezza di 20 diversi marmi pregiati, offrendo all'architettura contemporanea soluzioni progettuali di design.

The nobility of marble and the refinement of coloured veining find their perfect balance in Purity of Marble.  
A project range complete with porcelain stoneware and white body walltiles that uses ceramics to interpret the elegance and beauty of ten precious marbles offering today's architecture solutions for project design.

La noblesse du marbre et le raffinement de ses veinures chromatiques trouvent un parfait point de rencontre au sein de Purity of Marble.  
Un projet comprenant du grès cérame et des revêtements en pâte blanche qui interprète, sous le signe de la céramique, l'élégance et la beauté de dix marbres de valeur tout en offrant à l'architecture contemporaine des solutions conceptuelles de design.

Edler Marmor und elegante farbige Äderungen treffen bei Purity of Marble perfekt aufeinander.  
Ein komplettes Sortiment von Feinsteinzeug und weißscherbigen Wandfliesen lässt die Eleganz und Schönheit von zehn edlen Marmorarten und bietet der modernen Architektur ein Angebot von Designlösungen.



# 20 colours

La gamma di superfici "Purity of Marble" conta complessivamente 20 tipologie diverse di marmi. Realizzati con straordinario realismo in gres porcellanato e in pasta bianca, sono proposti in diversi formati e diverse finiture di superficie per rispondere a qualsiasi esigenza estetica e progettuale.

The "Purity of Marble" range of surfaces includes 20 different types of marble. These extraordinarily realistic white-body porcelain stoneware surfaces come in a range of sizes and surface finishes to meet any style and design need.

La gamme des surfaces "Purity of Marble" rassemble au total 20 typologies différentes de marbres. Réalisées avec un réalisme extraordinaire en grès cérame et en pâte blanche, elles sont proposées en plusieurs formats et finitions de surface pour répondre à toute exigence esthétique et conceptuelle.

Die Oberflächenauswahl „Purity of Marble“ umfasst insgesamt 20 verschiedene Marmorarten. Sie werden außerordentlich realistisch aus Feinsteinzeug und weißscherbiger Keramik gefertigt und in verschiedenen Formaten und Oberflächenausführungen angeboten, um alle ästhetischen Wünschen und Projektanforderungen gerecht zu werden.

# 2 technologies, 3 finish, 6 sizes

Purity of Marble è un progetto all'insegna della massima modularità e versatilità che offre la soluzione progettuale per ogni esigenza architettonica:

- **2 tecnologie:** gres porcellanato e rivestimento in pasta bianca.
- un'ampia gamma di formati: dalla lastra 120x278 sp. 6mm, ai grandi formati 120x120, 60x120, 75x150 e 75x75 a spessore tradizionale 9mm, il rivestimento in pasta bianca in formato 30.5x91.5.
- **3 finiture:** le grandi lastre 120x278 sono disponibili nella finitura **LUX** e **SILK**, mentre i formati 120x120, 60x120, 75x150 e 75x75 sono disponibili sia nella finitura **LUX** che **NATURALE**.

Purity of Marble is a project constructed around unrivalled modularity and versatility, with the right design solution for every architectural need:

- 2 product types: porcelain stoneware and white-body wall tiles

- a wide range of sizes: from the slab of 120x278 th. 6 mm to large tiles of 120x120, 60x120, 75x150 and 75x75 in the standard 9 mm thickness and the white-body wall tile in 30.5x91.5 size

- 3 surfaces: large slabs of 120x278 are available with GLOSSY and SILK surfaces, while the 120x120, 60x120, 75x150 and 75x75 sizes are offered in both GLOSSY and MATT.

Le projet Purity of Marble s'inscrit dans une modularité et une polyvalence maximales, offrant une solution de conception pour chaque exigence architecturale :

- 2 technologies : grès cérame et revêtement mural en pâte blanche

- une vaste gamme de formats: de la dalle 120x278 épaisseur 6 mm aux grands formats 120x120, 60x120, 75x150 et 75x75 à épaisseur classique de 9 mm et au revêtement mural en pâte blanche en 30.5x91.5

- 3 finitions: les grandes dalles 120x278 sont disponibles dans les finitions LUX et SILK, et les formats 120x120, 60x120, 75x150 et 75x75 dans la finition LUX et NATURALE.

Purity of Marble ist ein Programm im Zeichen maximaler Modularität und Flexibilität, das für alle gestalterischen Bedürfnisse die richtige Lösung bietet:

- 2 Technologien: Feinsteinzeug und Wandfliesen aus weißem Scherben

- ein großes Angebot an Formaten: von Platten 120x278 cm in Stärke 6 mm bis hin zu den Großformaten 120x120, 60x120, 75x150 und 75x75 cm in traditioneller Stärke, 9 mm und Fliesen aus weißem Scherben im Format 30.5x91.5 cm

- 3 Finishes – die großen Platten im Format 120x278 cm sind im Finish LUX und SILK erhältlich, die Formate 120x120, 60x120, 75x150 und 75x75 cm sind sowohl im Finish LUX als auch im Finish NATURALE erhältlich.

## GRES PORCELLANATO - PORCELAIN TILES

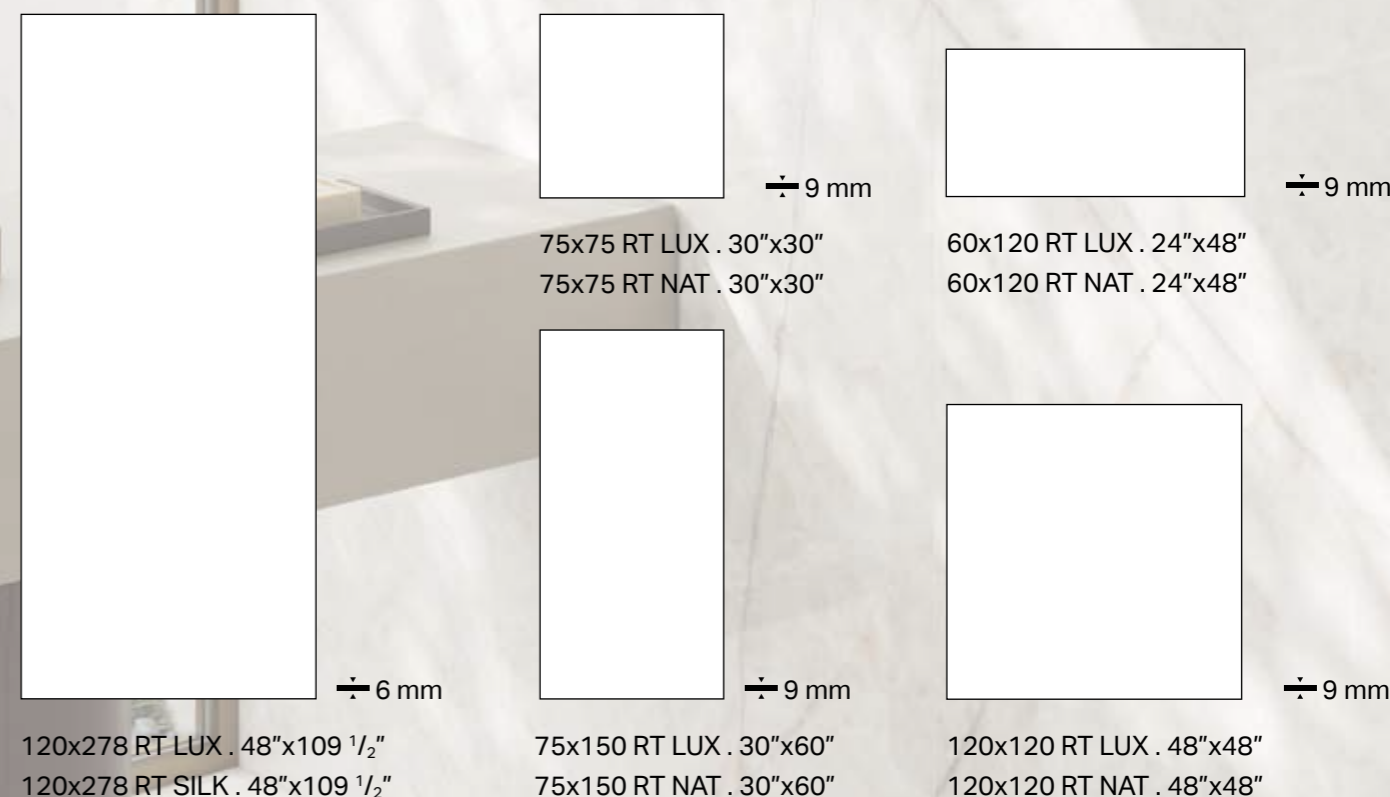

## RIVESTIMENTO IN PASTA BIANCA - WHITE BODY WALL TILES

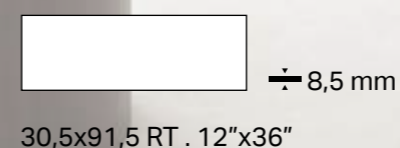

# 120x278

÷ 6 mm

## Massima espressione di bellezza naturale

The maximum expression of natural beauty.  
L'expression maximale de la beauté naturelle.  
Der höchste Ausdruck natürlicher Schönheit.



## Forza e valore estetico per pavimenti e rivestimenti

Strength and beauty for floor and wall coverings.  
Force et valeur esthétique pour sols et revêtements.  
Kraft und ästhetischer Wert für Fußböden und Verkleidungen.

La gamma di lastre Supergres in 120x278 cm, 6 mm di spessore, si completa perfettamente con il formato 120x120 cm, 9 mm di spessore, più resistente e adatto per pavimentazioni di ogni genere, sia residenziali che commerciali. Ciò consente massima libertà progettuale e risolve con stile ogni genere di esigenza applicativa.

The range of Supergres 120x278 cm, 6 mm thick slabs is completed with perfectly matching tiles in size 120x120 cm, 9 mm thick, which are stronger and more suited to all kinds of residential and commercial flooring. This ensures full design freedom and stylishly responds to all kinds of application needs.

La gamme de plaques Supergres dans le format 120x278 cm, de 6 mm d'épaisseur, est complétée par des plaques qui se coordonnent parfaitement avec le format 120x120 cm, de 9 mm d'épaisseur, plus résistantes et adaptées à des sols de toute nature, aussi bien résidentielle que commerciale. Cela permet une liberté conceptuelle maximale tout en résolvant avec style chaque exigence en matière d'application.

Die Palette der Supergres-Platten 120x278 cm, 6 mm dick, wird durch perfekt passende Platten 120x120 cm, 9 mm dick, ergänzt, die widerstandsfähiger sind und sich für Böden aller Art eignen, sowohl für Wohn- als auch für Geschäftsräume. Dies ermöglicht ein Maximum an Gestaltungsfreiheit und löst alle Arten von Anwendungsanforderungen mit Stil.

# I vantaggi delle grandi lastre Supergres

**The advantages of Supergres large slabs.**  
**Les avantages des grandes plaques Supergres.**  
**Die Vorteile von großen Supergres-Platten.**

Grazie a straordinarie caratteristiche di leggerezza e duttilità diventa possibile rivestire volumi e seguire forme complesse per coordinare ogni elemento dell'ambiente alle superfici di pavimenti e pareti. Una espressione estetica che racchiude tutte le potenzialità tecniche del gres porcellanato Supergres. Un materiale ideale per il design che consente di realizzare su misura ogni genere di elemento inserito nell'ambiente.

With their extraordinary lightness and flexibility, it is possible to cover any room, following complex shapes to coordinate every element in the room with the floor and wall coverings. An aesthetic expression that embodies all the technical potential of Supergres porcelain stoneware. The ideal material for design, allowing any element in the room to be made to measure.

Grâce à des caractéristiques extraordinaires en matière de légèreté et de ductilité, il devient possible de revêtir des volumes et de suivre des formes complexes pour assortir chaque élément de l'environnement avec les surfaces de sols et de murs. Une expression esthétique qui contient toutes les potentialités techniques du grès cérame Supergres. Un matériau idéal pour le design qui permet de réaliser, sur mesure, chaque genre d'élément inséré dans l'environnement.

Dank der außerordentlichen Eigenschaften von Leichtigkeit und Dehnbarkeit ist es möglich, Volumen abzudecken und komplexen Formen zu folgen, um jedes Element der Umgebung mit den Oberflächen von Böden und Wänden zu koordinieren. Ein ästhetischer Ausdruck, der das gesamte technische Potenzial des Supergres-Feinsteinzeugs in sich vereint. Ein ideales Material für die Gestaltung, das es ermöglicht, jedes Element in der Umgebung individuell zu gestalten.



**Ampia gamma di stili**  
Wide range of styles.  
Vaste gamme de styles.  
Große Auswahl an Stilen.



**Salubre**  
Healthy.  
Salubres.  
Gesund.



**Leggero**  
Light.  
Légères.  
Leichtigkeit.



**Non assorbe**  
Non-absorbent.  
N'absorbent pas.  
Nicht absorbierend.



**Facile da movimentare**  
Easy to handle.  
Faciles à transporter.  
Leicht zu handhaben.



**Facile da pulire**  
Easy to clean.  
Faciles à nettoyer.  
Leicht zu reinigen.



**Facile da tagliare e sagomare**  
Easy to cut and shape.  
Faciles à couper et à usiner.  
Leicht zu schneiden und zu formen.



**Resiste agli acidi**  
Resistant to acids.  
Résistantes aux acides.  
Säurebeständig.



**Resistenti al gelo**  
Frost-resistant.  
Résistantes au gel.  
Frost-sicher.



**Resiste ai raggi UV**  
Resistant to UV rays.  
Résistantes aux rayons UV.  
UV-beständig.



**Resiste al calore**  
Heat-resistant.  
Résistantes à la chaleur.  
Hitzebeständig.



**Ignifugo**  
Fire-resistant.  
Ignifuges.  
Feuerfest.



## GRANDE E MODULARE

LARGE AND MODULAR.  
GRANDE ET MODULAIRE.  
GROSS UND MODULAR.

Dimensioni elevate (circa 3.36 m<sup>2</sup> a pezzo) altezza ideale per l'altezza pareti standard. Formato ideale per rivestimento fino a soffitto, senza tagli e riducendo sprechi.

Large size (approx. 3.36 m<sup>2</sup> per piece) and ideal height for covering standard walls up to the ceiling, reducing cutting and waste.

Des dimensions élevées (environ 3,36 m<sup>2</sup> par pièce) et une hauteur idéale pour revêtir des murs standards jusqu'au plafond, en réduisant ainsi les coupes et les gaspillages.

Großes Format (ca. 3.36 qm pro Stück) und ideale Höhe zum Abdecken von Standardwänden bis zur Decke, wodurch Schnitt und Abfall reduziert werden.



## MINORE NUMERO DI FUGHE

FEWER GAPS.  
NOMBRE RÉDUIT DE JOINTS.  
WENIGER FUGEN.

Le elevate dimensioni della lastra esaltano la bellezza della grafica e permettono di apprezzare l'intero sviluppo senza interruzioni.

The large size of the slab exalts the beauty of the graphics, allowing the whole pattern to be appreciated without any interruptions.

Les dimensions élevées de la plaque exaltent la beauté du graphisme et permettent d'en apprécier le développement dans sa totalité sans interruptions.

Das große Format der Platte unterstreicht die Schönheit der Grafik und ermöglicht es, die gesamte Konstruktion ohne Unterbrechungen zu betrachten.



## INALTERABILE NEL TEMPO

LASTING BEAUTY.  
INALTÉRABLE AU FIL DU TEMPS.  
UNVERÄNDERLICH IM LAUFE DER ZEIT.

Le lastre 120x278 presentano tutte le caratteristiche tecniche del gres a spessore tradizionale e mantengono inalterate nel tempo prestazioni, colori ed estetica.

The 120x278 slabs have all the technical characteristics of conventional thickness stoneware, while maintaining their performance, colour and beauty over time.

Les plaques 120x278 présentent toutes les caractéristiques techniques du grès d'une épaisseur traditionnelle et conservent inaltérées dans le temps leurs performances, leurs couleurs et leur esthétique.

Die Platten 120x278 weisen alle technischen Merkmale des traditionellen dicken Feinsteinzeugs auf und behalten im Laufe der Zeit ihre Leistung, Farbe und Ästhetik unverändert bei.



## VERSATILITÀ

VERSATILITY.  
VERSATILITÉ.  
VIELSEITIGKEIT.

Libertà e flessibilità per la realizzazione di qualsiasi progetto, per rivestire volumi, pareti, oggetti d'arredo.

Freedom and flexibility for any project, for covering floors, walls and furnishing elements.

Liberté et flexibilité pour la réalisation de tous les types de projet pour revêtir des volumes, des murs et des objets de décoration.

Freiheit und Flexibilität für die Realisierung eines jeden Projekts, um Volumen, Wände, Einrichtungsgegenstände zu bedecken.



## SOTTILE, LEGGERO, RESISTENTE

THIN, LIGHT, STRONG.  
FINE, LÉGÈRE, RÉSTANTE.  
DÜNN, LEICHT, WIDERSTANDSFÄHIG.

Lo spessore di soli 6 mm, garantisce leggerezza, maggiore facilità nella movimentazione e nella lavorazione delle lastre, pur mantenendo la resistenza e le elevate prestazioni tecniche del gres porcellanato.

In just 6 mm, the slab guarantees lightness, easier handling and machining, without compromising on the strength and high technical performance of porcelain stoneware.

L'épaisseur de 6 mm seulement garantit une légèreté et une plus grande facilité de manutention et d'usinage des plaques tout en conservant la résistance et les performances techniques élevées du grès cérame.

Die Stärke von nur 6 mm garantiert Leichtigkeit, einfachere Handhabung und Verarbeitung der Platten, wobei die Festigkeit und die hohen technischen Leistungen des Feinsteinzeugs erhalten bleiben.

## 20 Vein matching

**Finitura Silk:** Statuario Silk, Arabescato Silk, Elegant Greige Silk, Crystal Silk, Patagonia Silk, Eden Silk, Calacatta Silk, Capraia Silk

**Finitura Lux:** Statuario Lux, Arabescato Lux, Elegant Greige Lux, Crystal Lux, Patagonia Lux, Eden Lux, Calacatta Lux, Supreme Dark Lux, Royal Beige Lux, Invisible Blue Lux, Mysterious White Lux, Green Calacatta Lux

Numerosi articoli della gamma Purity of Marble possono essere posati con continuità di venatura tra una lastra e la successiva (vein matching), permettendo di ottenere una grafica continua sulla parete, come nei marmi più pregiati.

Per maggiori dettagli relativi al vein matching, vedere a pag 132 di questo catalogo.

Many articles in the Purity of Marble range can be installed with vein matching (continuity of vein between slabs) to produce unbroken patterning on the wall, as with the finest marbles  
 For more information about vein matching, see page 132 of this catalogue.

La plupart des articles de la gamme Purity of Marble peuvent se poser dans la continuité des veines entre une dalle et l'autre (vein matching), permettant ainsi d'obtenir un motif graphique continu sur le mur, comme dans les marbres les plus nobles.

Pour plus de précisions sur le vein matching, voir la page 132 de ce catalogue.

Zahlreiche Artikel aus dem Sortiment Purity of Marble können mit durchgängiger Äderung zwischen einer Platte und der nächsten verlegt werden (vein matching). Dies ermöglicht ein fortlaufendes grafisches Muster an den Wänden wie bei den edelsten Marmorsteinen.

Ausführlichere Angaben zum vein matching finden sie auf S. 132 dieses Katalogs.

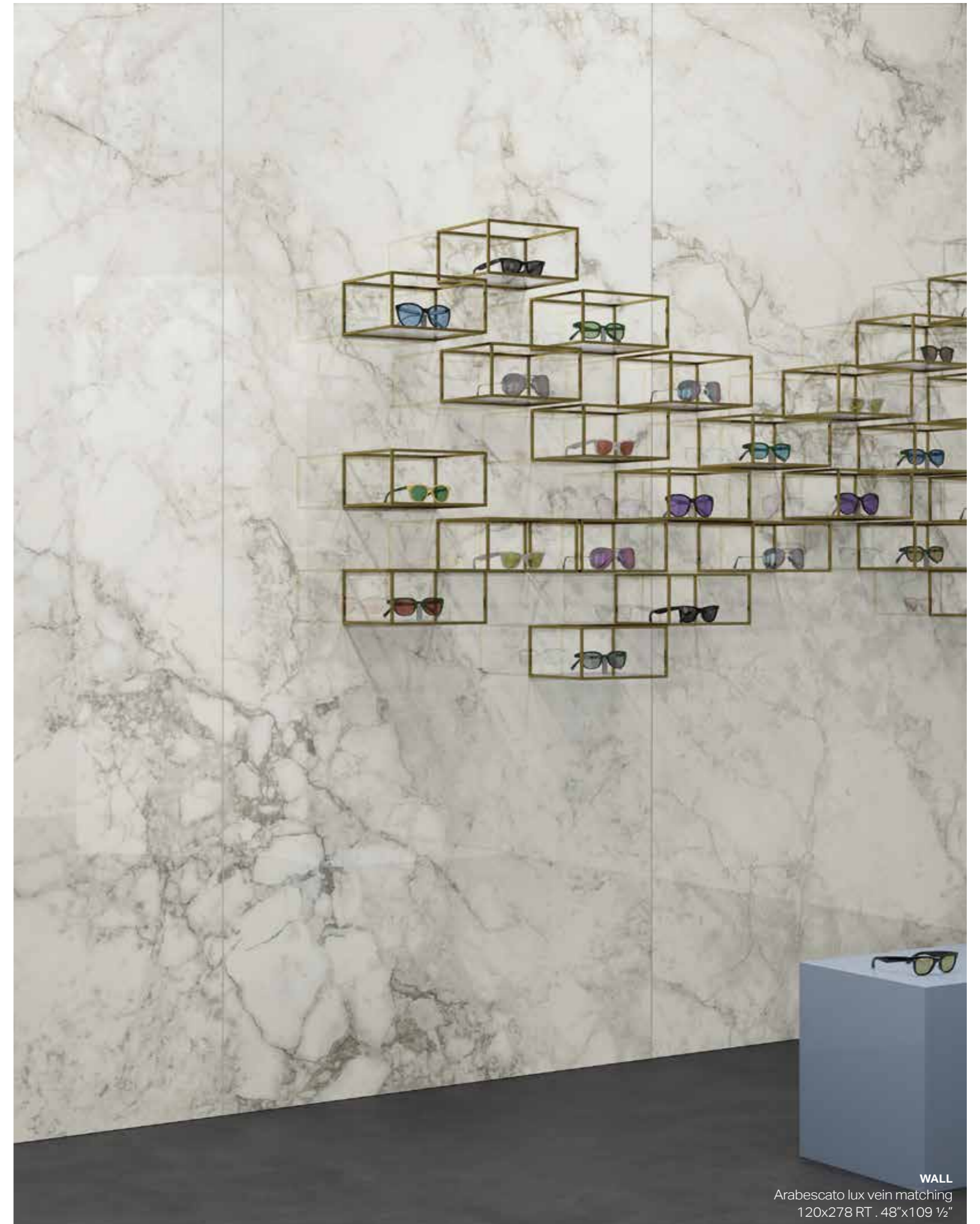

**WALL**  
 Arabescato lux vein matching  
 120x278 RT . 48"x109 1/2"



# PURITY OF MARBLE

Pure White.....	16
Eden.....	20
Statuario.....	24
Arabescato.....	32
Invisible Blue.....	38
Lasa.....	46
Calacatta.....	50
Crystal.....	56
Mysterious White.....	62
Capraia.....	68
Marfil.....	72
Royal Beige.....	76
Paradiso.....	82
Elegant Greige.....	86
Patagonia.....	90
Green Calacatta.....	96
Orobica Grigia.....	100
Onyx Pearl.....	104
Supreme Dark.....	108
Breccia Nera.....	114

CERAMICHE  
SUPERGRES

# PURE WHITE

## SILK



120x278 RT . 48"x109 1/2" ÷ 6 mm

## LUX



120x278 RT . 48"x109 1/2" ÷ 6 mm



120x120 RT . 48"x48" ÷ 9 mm



75x150 RT . 30"x60" ÷ 9 mm



75x75 RT . 30"x30" ÷ 9 mm



60x120 RT . 24"x48" ÷ 9 mm

## NATURALE . NATURAL



120x120 RT . 48"x48" ÷ 9 mm



60x120 RT . 24"x48" ÷ 9 mm

**Il bianco nella sua purezza più essenziale si arricchisce di venature e sfumature profonde che accentuano la sofisticata eleganza di Pure White.**

White in all its simplest purity is enriched by veining and deep shades that accentuate the sophisticated elegance of Pure White.

Le blanc dans sa pureté la plus essentielle s'enrichit de veinures et de nuances profondes qui accentuent l'élégance sophistiquée de Pure White.

Weiß in seiner elementaren Reinheit ist mit Adern und tiefen Farbnuancen angereichert, die die edle Eleganz von Pure White noch hervorheben.



Pure White lux 120x278 RT . 48"x109 1/2"



**WALL**  
Pure White lux  
120x278 RT . 48"x109 1/2"

**FLOOR**  
Pure White lux  
120x120 RT . 48"x48"

# EDEN

## SILK

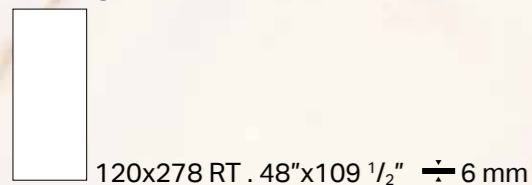

## LUX

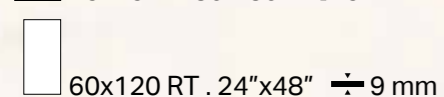
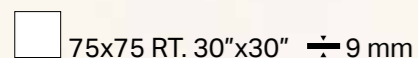
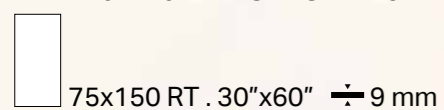
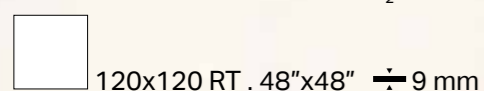
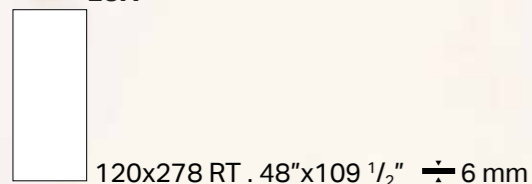

## NATURALE . NATURAL

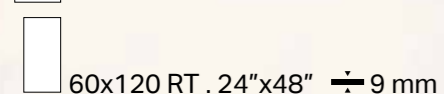
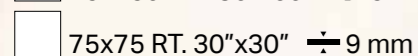
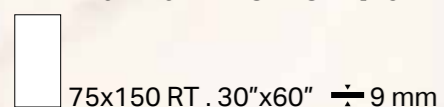
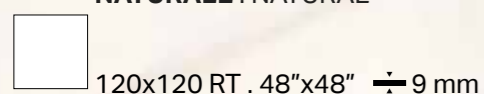

**Sfumature grigio dorate si rincorrono su uno sfondo bianco e luminoso. A tratti più sottili, a tratti più marcate, caratterizzano la superficie delicata ed estremamente raffinata di questo marmo prestigioso. Il marmo bianco, da sempre simbolo di purezza, icona di prestigio ed eleganza è un classico dell'architettura che si addice perfettamente anche al design contemporaneo.**

Golden grey shades chase each other against a bright white background. The delicate and extremely refined surface of this prestigious marble is characterised by these shades, at times more subtle, at others more pronounced.

White marble, which has always been a symbol of purity, an icon of prestige and elegance, is an architectural classic that is also perfectly suited to contemporary design.

Des nuances gris doré se poursuivent sur un fond blanc et lumineux. Fines, ou plus marquées, elles caractérisent la surface délicate et extrêmement raffinée de ce marbre prestigieux. Depuis toujours symbole de pureté, d'icône prestigieuse et d'élégance, le marbre blanc est un classique de l'architecture qui convient aussi parfaitement au design contemporain.

Eine Abfolge von goldenen Grautöne vor einem strahlend weißen Hintergrund. Mal subtiler, mal ausgeprägter, charakterisieren sie die zarte und äußerst raffinierte Oberfläche dieses prestigeträchtigen Marmors.

Weißer Marmor, der seit jeher ein Symbol der Reinheit, des Prestiges und der Eleganz ist, ist ein architektonischer Klassiker, der sich auch perfekt für zeitgenössisches Design eignet.



**WALL**  
Eden Lux  
120x278 RT . 48"x109 1/2"

**FLOOR**  
Eden Lux  
120x120 RT . 48"x48"



**WALL**  
Eden Lux  
120x278 RT . 48"x109 1/2"

**FLOOR**  
Eden Lux  
120x120 RT . 48"x48"

# STATUARIO

## SILK



120x278 RT . 48"x109 1/2" ± 6 mm

## LUX



120x278 RT . 48"x109 1/2" ± 6 mm



120x120 RT . 48"x48" ± 9 mm



75x150 RT . 30"x60" ± 9 mm



75x75 RT . 30"x30" ± 9 mm



60x120 RT . 24"x48" ± 9 mm

## NATURALE . NATURAL



120x120 RT . 48"x48" ± 9 mm



60x120 RT . 24"x48" ± 9 mm

## RIVESTIMENTI . WALL

30,5x91,5 RT . 12"x36" ± 8,5 mm

**Lussuoso, elegante, scultoreo.**  
Il marmo Statuario abita gli spazi più raffinati e, grazie alle molteplici venature grigie che attraversano la sua superficie bianca, garantisce dinamicità estetica agli ambienti, arricchendoli di un'impagabile brillantezza ed eleganza.

Luxurious, elegant and sculptural. Statuario marble embraces the most refined spaces and, thanks to the multiple grey veining that streaks along its white surface, guarantees aesthetic dynamicity to the ambiances, enriching them with brilliance and elegance of inestimable value.

Luxeux, élégant, sculptural. Le marbre Statuario revêt les espaces les plus raffinés et, grâce aux nombreuses veines grises qui sillonnent sa surface blanche, il garantit un dynamisme esthétique aux espaces, en les enrichissant d'une brillante et élégance uniques.

Leuchtend, elegant, plastisch. Der Marmor Statuario gestaltet, dank seiner zahlreichen grauen Aderungen, die sich kunstvoll über die weiße Oberfläche hinwegziehen, raffinierte Umgebungen und sorgt für ästhetische Dynamik von unschätzbare Brillanz und Eleganz.

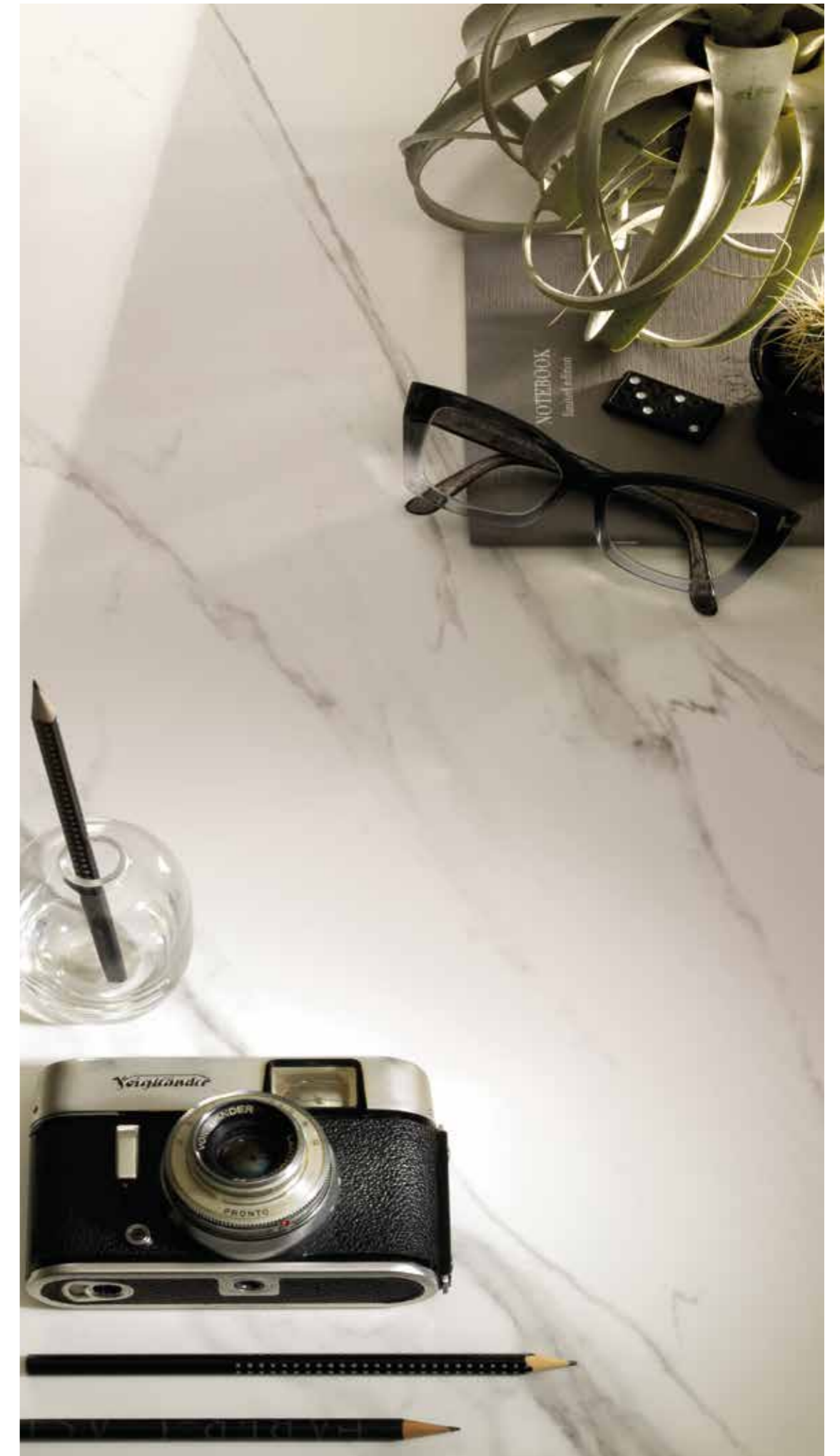

**WALL**  
Serie ART: ART graphite struttura sign  
30,5x91,5 RT . 12"x36"

**FLOOR**  
Statuario lux  
75x150 RT . 30"x60"





**WALL**  
Statuario Silk Vein matching  
120x278 RT . 48"x109 1/2"

**FLOOR**  
Serie Colovers: Love Black  
120x120 RT . 48"x48"





**WALL**

Statuario 30,5x91,5 RT . 12"x36"  
Statuario struttura fluid 30,5x91,5 RT . 12"x36"  
Serie STONWORK: Ardesia nera 60x120 RT . 24"x48"

**FLOOR**

Statuario lux 75x75 RT . 30"x30"  
Serie STONWORK T20: Ardesia nera T20 60x120 RT . 24"x48"

# ARABESCATO

Distribuitor în România – Gada Ceramic București, Str. Vlad Juțețu 48  
 Website: [www.gadaceramic.ro](http://www.gadaceramic.ro)

## SILK

 120x278 RT . 48"x109 1/2" ± 6 mm

## LUX

 120x278 RT . 48"x109 1/2" ± 6 mm

 120x120 RT . 48"x48" ± 9 mm

 75x150 RT . 30"x60" ± 9 mm

 75x75 RT. 30"x30" ± 9 mm

 60x120 RT . 24"x48" ± 9 mm

## NATURALE . NATURAL

 60x120 RT . 24"x48" ± 9 mm

 75x150 RT . 30"x60" ± 9 mm

 75x75 RT. 30"x30" ± 9 mm

**Classico e intramontabile, Arabescato trasferisce agli ambienti un'atmosfera elegante e raffinata. Lo straordinario realismo e la cura del dettaglio si uniscono alle performance del gres porcellanato per realizzare ogni desiderio progettuale**

Classic and timeless, Arabescato brings an elegant, sophisticated air to living spaces. The extraordinary realism and attention to detail combine with the performance of porcelain stoneware to make all your design dreams come true.

Classique et indémodable, Arabescato transfère aux espaces une atmosphère élégante et raffinée. Le réalisme extraordinaire et le soin du détail s'unissent aux performances du grès cérame pour réaliser chaque désir en matière de conception.

Klassisch und zeitlos, verleiht Arabescato den Räumen eine elegante und edle Atmosphäre. Außergewöhnlicher Realismus und Liebe zum Detail verbinden sich mit den Leistungen des Feinsteinzeugs, um jeden Gestaltungswunsch zu verwirklichen.



Arabescato Lux 120x120 RT . 48"x48"

**WALL**  
 Arabescato lux 120x278 RT . 48"x109 1/2"



**FLOOR**  
Arabescato Lux 120x120 RT . 48"x48"

**WALL**  
Arabescato lux 120x278 RT . 48"x109 1/2"



**FLOOR**  
Arabescato Lux 120x120 RT . 48"x48"

**WALL**  
Arabescato Lux 120x278 RT . 48"x109 1/2"

# INVISIBLE BLUE

## LUX

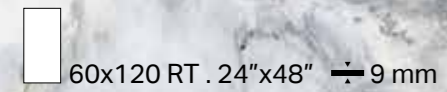
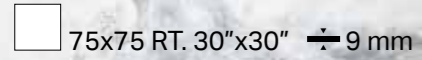
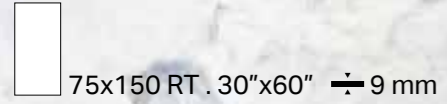
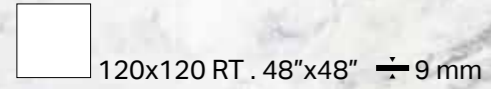
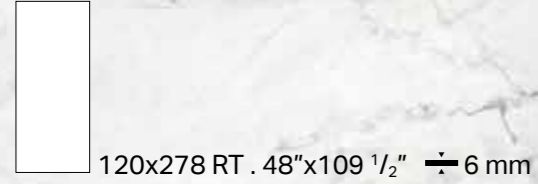

## NATURALE . NATURAL

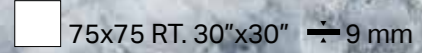
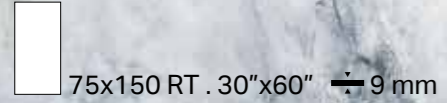

**Un design puro e lineare, simbolo di prestigio e bellezza. Con Invisible Blue la venatura diventa assoluta protagonista con in suoi movimenti in estensione, sinuosi e decorativi, creando un effetto a contrasto magnetico e seducente.**

Pure, linear design, emblematic of beauty and prestige. With Invisible Blue, the graceful, decorative extension of the veining effects create an alluring, sensual effect.

Un design pur et linéaire, symbole de prestige et de beauté. Avec Invisible Blue, la veinure devient la protagoniste absolue avec ses mouvements en extension, sinueux et décoratifs, en créant un effet contrasté magnétique et séduisant.

Ein reines und lineares Design, ein Symbol für Prestige und Schönheit. Bei Invisible Blue wird die Maserung zum absoluten Protagonisten mit ihren ausgedehnten, gewundenen und dekorativen Bewegungen, die einen magnetischen und verführerischen Kontrasteffekt erzeugen.

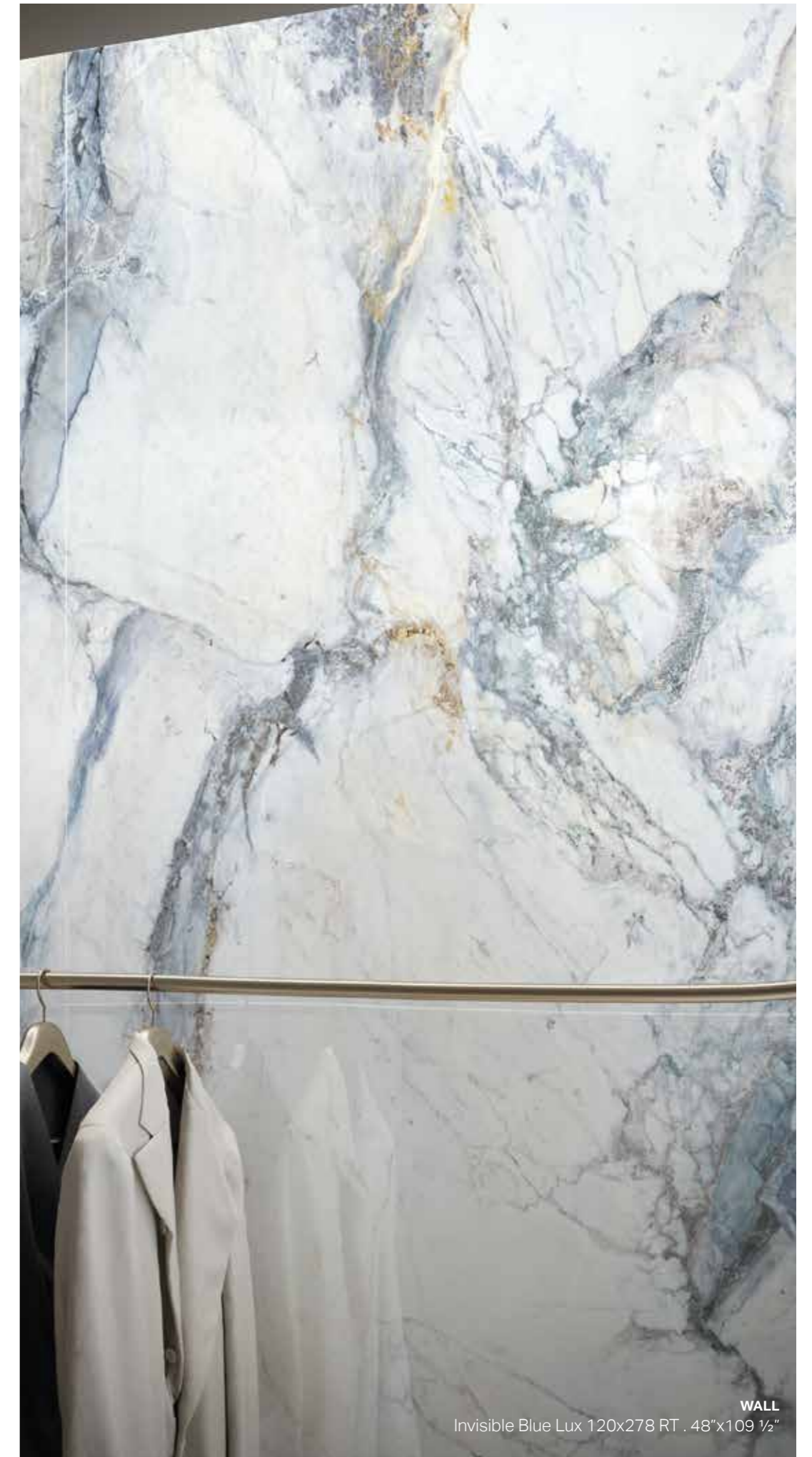

WALL  
Invisible Blue Lux 120x278 RT . 48"x109 1/2"

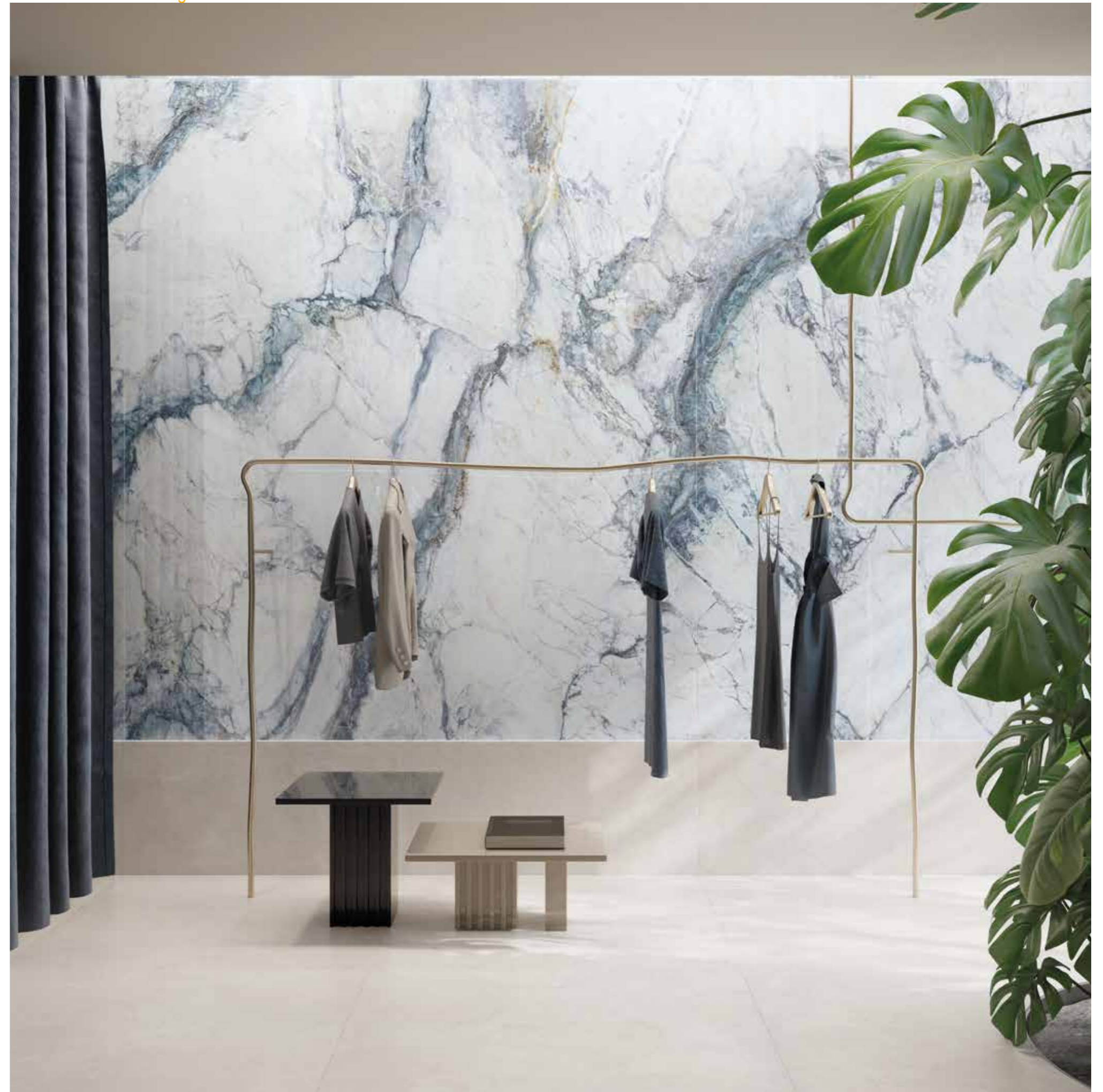

**FLOOR**  
Ray Greige 120x120 RT . 48"x48"  
Serie Rayclay

**WALL**  
Invisible Blue Lux Vein Matching 120x278 RT . 48"x109 1/2"



**FLOOR**  
Invisible Blue lux 120x120 RT . 48"x48"  
H.Concrete T20 120x120RT - 48"48" Serie H24

**WALL**  
Ray Dark 120x278 RT . 48"x109 1/2"  
Serie Rayclay



**FLOOR**  
Ray Greige 120x120 RT . 48"x48"  
Serie Rayclay

**WALL**  
Invisible Blue Lux 120x278 RT . 48"x109 1/2"







# LASA

## LUX

 120x120 RT . 48"x48" ➔ 9 mm

 75x150 RT . 30"x60" ➔ 9 mm

 75x75 RT . 30"x30" ➔ 9 mm

 60x120 RT . 24"x48" ➔ 9 mm

## NATURALE . NATURAL

 60x120 RT . 24"x48" ➔ 9 mm

## RIVESTIMENTI . WALL

 30,5x91,5 RT . 12"x36" ➔ 8,5 mm

**Purity of marble reinterpreta il marmo Lasa, uno dei più pregiati al mondo, apprezzato per il suo aspetto omogeneo, puro e luminoso. Le delicate venature rivelano tutta la storia della materia ed impreziosiscono gli ambienti di spazi residenziali e commerciali.**

Purity of Marble reinterprets Lasa marble, one of the finest quality marbles in the world, widely appreciated for its uniform appearance, pure and bright. Its delicate veining reveals the entire story of matter and makes ambiances precious, be they residential or commercial.

Purity of marble réinterprète le marbre Lasa, l'un des plus précieux au monde, apprécié pour son aspect homogène, pur et lumineux. Les délicates veines révèlent toute l'histoire de la matière et subliment les espaces de contextes résidentiels et commerciaux.

Purity of marble interpretiert den Marmor Lasa, einer der schönsten der Welt, hoch geschätzt für sein gleichmäßiges Erscheinungsbild, rein und hell, neu. Die zarten Aderungen enthüllen die ganze Geschichte dieses Werkstoffes und entfalten in Wohn- und Geschäftsräumen zurückhaltenden Luxus.



**WALL**  
Lasa lux  
75x150 RT . 30"x60"

**FLOOR**  
Lasa lux  
75x150 RT . 30"x60"



# CALACATTA

## SILK

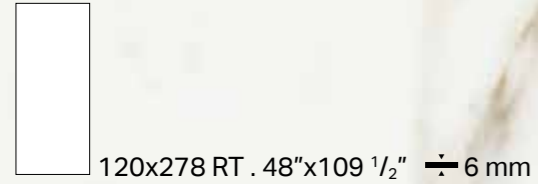

## LUX

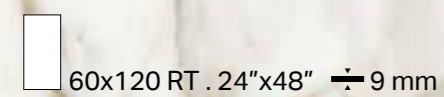
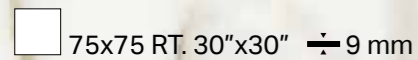
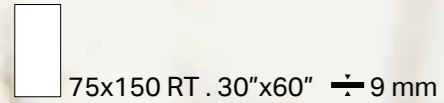
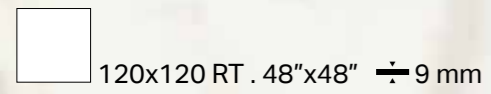
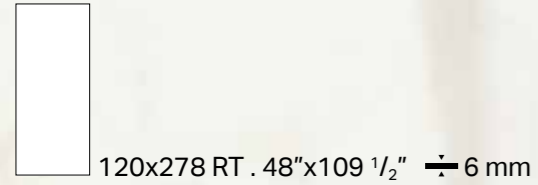

## NATURALE . NATURAL

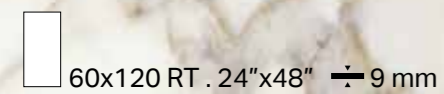
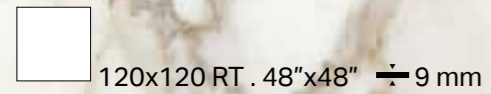

## RIVESTIMENTI . WALL

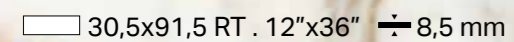

**La migliore  
selezione di  
Calacatta,  
caratterizzata  
da inconfondibili  
venature e  
dettagliate  
sfumature di  
colore, crea  
ambienti esclusivi,  
contraddistinti da  
un'eleganza senza  
tempo.**

The best selection of Calacatta, characterized by deep veining and detailed color hues, creates exclusive ambiances, marked by a timeless elegance.

La meilleure sélection de Calacatta, caractérisée par des veines incomparables et des nuances de couleur détaillées, crée des espaces exclusifs, caractérisés par une élégance intemporelle.

Die beste Auswahl an Calacatta, charakterisiert durch unverkennbare Aderungen und detaillierte Farbverläufe, schafft exklusive Ambiente, die sich durch zeitlose Eleganz auszeichnen.





**WALL**  
Calacatta 30,5x91,5 RT . 12"x36"  
Calacatta strutt. fluid 30,5x91 RT . 12"x36"

**FLOOR**  
Serie ART: Art tobacco 75x150 RT . 30"x60"



**WALL**  
Calacatta lux  
75x150 RT . 30"x60"  
Profilo metallo oro  
0,5x100 . 0,2"x40"

**FLOOR**  
Calacatta lux  
75x150 RT . 30"x60"

# CRYSTAL

Distribuitor în România – Gada Ceramic București, Str. Vlad Județu 48  
Website: [www.gadaceramic.ro](http://www.gadaceramic.ro)

**Venature e intrecci caratterizzano la superficie di Crystal, e disegnano sfumature ore lievi, ora più marcate, dal colore dorato. Un mondo di lusso senza tempo che trasmette un forte senso di unicità.**

Veins and intertwined effects bring character to the surface of Crystal, shaping subtle, shifting shades of gold, for a luxurious, timeless look that conveys a truly unique sensation.

Des veinures et des entrelacements caractérisent la surface de Crystal et dessinent des nuances, tantôt légères, tantôt plus prononcées, à la couleur dorée. Un monde de luxe atemporel qui transmet une sensation intense d'unicité.

Maserungen und Verflechtungen prägen die Oberfläche von Crystal und zeichnen mal leichte, mal ausgeprägtere Nuancen mit einer goldenen Farbe. Eine Welt des zeitlosen Luxus, die ein starkes Gefühl der Einzigartigkeit vermittelt.

**SILK**  
120x278 RT . 48"x109 1/2" ⇄ 6 mm

**LUX**  
120x278 RT . 48"x109 1/2" ⇄ 6 mm

120x120 RT . 48"x48" ⇄ 9 mm

75x150 RT . 30"x60" ⇄ 9 mm

75x75 RT . 30"x30" ⇄ 9 mm

60x120 RT . 24"x48" ⇄ 9 mm

**NATURALE . NATURAL**  
120x120 RT . 48"x48" ⇄ 9 mm

75x150 RT . 30"x60" ⇄ 9 mm

75x75 RT . 30"x30" ⇄ 9 mm

60x120 RT . 24"x48" ⇄ 9 mm



**FLOOR**  
Crystal Lux 120x120 RT .  
48"x48"

**WALL**  
Supreme Dark 120x278 RT .  
48"x109 1/2"



**FLOOR**  
Crystal Lux 120x120 RT . 48"x48"

**WALL**  
Supreme Dark 120x278 RT . 48"x109 1/2"



**FLOOR**  
Ray Moon 120x120 RT . 48"x48"  
Serie RayClay

**WALL**  
Crystal Lux 120x278 RT . 48"x109 1/2"





# MYSTERIOUS WHITE

LUX

-  120x278 RT . 48"x109 1/2" ± 6 mm
-  120x120 RT . 48"x48" ± 9 mm
-  75x150 RT . 30"x60" ± 9 mm
-  75x75 RT . 30"x30" ± 9 mm
-  60x120 RT . 24"x48" ± 9 mm

**Si inspira ai marmi apuani più preziosi e ricercati. Le venature che caratterizzano la sua superficie sono contraddistinte da sfumature di colore e di dettagli che la rendono calda e avvolgente. Mysterious White è ricco di carattere, elegante e passionale, come l'antica terra che lo genera.**

It draws inspiration from the most precious and sought-after Apuan marbles. The veining of its surface is characterised by shaded colours and details that make it warm and enveloping. Mysterious White is rich in character, elegant and passionate, like the ancient soil it comes from.

Elle s'inspire des marbres des Alpes apuanes les plus précieux et recherchés. Les veines distinctives de sa surface sont caractérisées par des nuances de couleurs et de détails qui la rendent chaleureuse et accueillante. Mysterious White, élégante et passionnée, a un fort caractère, comme sa terre d'origine ancienne.

Das Finish inspiriert sich an den wertvollsten und raffiniertesten apuanischen Marmorsorten. Die Äderungen, die seine Oberfläche charakterisieren, sind von Farbnuancen und Details geprägt, die sie warm und einladend machen. Mysterious White hingegen ist voller Charakter, elegant und leidenschaftlich, wie der antike Boden, der ihn hervorbringt.



**WALL**  
Mysterious White Lux  
120x278 RT . 48"x109 1/2"

**FLOOR**  
Mysterious White Lux  
120x120 RT . 48"x48"  
Natural Wild  
19,7x120 RT . 7 3/4"x48" serie Natural Appeal



**WALL**  
Mysterious White Lux  
120x278 RT . 48"x109 1/2"

**FLOOR**  
Mysterious White Lux  
120x120 RT . 48"x48"  
Natural Wild  
19,7x120 RT . 7 3/4"x48" serie Natural Appeal



**WALL**  
Mysterious White Lux 120x278 RT . 48"x109 1/2"

**FLOOR**  
Mysterious White Lux 75x150 RT . 30"x60"  
Mysterious White Gradone c/p. incollato  
33x150 RT . 13,2"x60"

# CAPRAIA

## SILK



120x278 RT . 48"x109 1/2" ⇄ 6 mm

## LUX



120x120 RT . 48"x48" ⇄ 9 mm



60x120 RT . 24"x48" ⇄ 9 mm

## NATURALE . NATURAL



60x120 RT . 24"x48" ⇄ 9 mm

**Su un fondo bianco puro, si intrecciano venature che sfumano dal grigio al bordeaux, che caratterizzano uno dei marmi più pregiati, dando vita ad ambienti unici, raffinati, di puro design.**

A pure white background is streaked by crossing veins ranging from grey to burgundy, which distinguish one of the finest marbles, creating unique, sophisticated settings with a pure design.

Sur un fond blanc pur se mêlent des veines qui vont du gris au bordeaux, pour caractériser un des marbres les plus précieux, donnant vie à des espaces uniques, raffinés, de pur design.

Auf einer purweißen Grundfarbe verweben sich Maserungen in den Farben von Grau bis Bordeaux und charakterisieren einen der wertvollsten Marmorsteine, mit dem einzigartig raffinierte Design-Umgebungen gestaltet werden können.

**WALL**  
Capraia Silk  
120x278 RT . 48"x109 1/2"

**FLOOR**  
Capraia  
60x120 RT . 24"x48"





**WALL**  
Capraia Silk Vein matching  
120x278 RT . 48"x109 1/2"  
H. Concrete  
120x278 RT . 48"x109 1/2" serie H24

**FLOOR**  
Capraia  
60x120 RT . 24"x48"

# MARFIL

## SILK



120x278 RT . 48"x109 1/2" ➔ 6 mm

## LUX



120x120 RT . 48"x48" ➔ 9 mm



75x150 RT . 30"x60" ➔ 9 mm



75x75 RT. 30"x30" ➔ 9 mm



60x120 RT . 24"x48" ➔ 9 mm

## NATURALE . NATURAL



120x120 RT . 48"x48" ➔ 9 mm



60x120 RT . 24"x48" ➔ 9 mm

## RIVESTIMENTI . WALL



30,5x91,5 RT . 12"x36" ➔ 8,5 mm

**Declinata nelle calde tonalità del Marfil, la purezza ispirativa del marmo trasferisce agli ambienti armonia e naturalezza, rivestendo con eleganti sfumature gli spazi residenziali e commerciali.**

Expressed in the warm shades of Marfil, the inspirational purity of marble brings harmony and naturalness to any environment, enveloping residential and commercial spaces with elegant nuances.

Déclinée dans les chaleureuses nuances de Marfil, la pureté inspirée du marbre apporte naturel et harmonie aux espaces résidentiels et commerciaux qu'elle revêt d'élégantes nuances.

Die inspirierende Reinheit von Marmor in den warmen Farbtönen von Marfil verleiht Räumen Harmonie und Natürlichkeit, und gibt Wohn- und Gewerbebereichen ein elegantes Flair.



Marfil lux 75x150 RT . 30"x60"

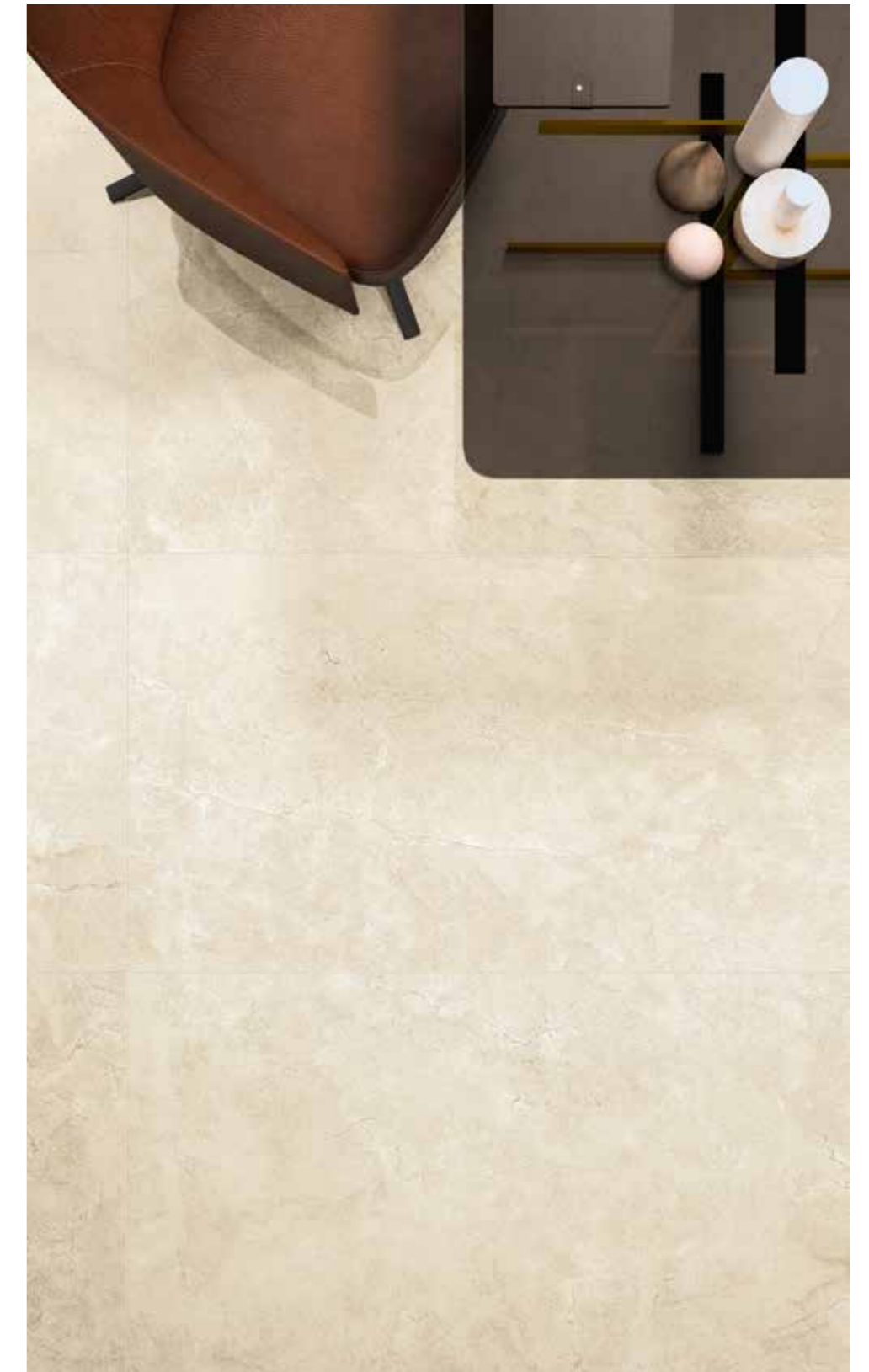

Marfil lux 75x150 RT . 30"x60"

# ROYAL BEIGE

## LUX



120x278 RT . 48"x109 1/2" ± 6 mm



120x120 RT . 48"x48" ± 9 mm



60x120 RT . 24"x48" ± 9 mm

## NATURALE . NATURAL



60x120 RT . 24"x48" ± 9 mm

## RIVESTIMENTI . WALL



30,5x91,5 RT . 12"x36" ± 8,5 mm

**Avvolgente e intimo, Royal Beige custodisce il fascino di uno stile impeccabile. Delicate sfumature si alternano a venature più decise, donando agli ambienti una perfezione estetica intramontabile, insensibile alle mode del tempo.**

Enveloping and intimate, Royal Beige preserves the charm of an impeccable style. Delicate nuances alternate with bolder veining effects to give the environments a timeless look that never goes out of style.

Caressante et intime, Royal Beige garde le charme d'un style impeccable. De délicates nuances s'alternent à des veinures plus marquées, donnant aux espaces une impérissable perfection esthétique, indifférente aux modes.

Royal Beige lässt mit dem Charme seines vollendeten Stils ein gemütliches und intimes Ambiente entstehen. Zarte Farbtöne wechseln mit markanten Äderungen ab und verleihen den Räumen eine zeitlose Ästhetik, der die Moden der Zeit nichts anhaben können.







**WALL**  
Royal Beige lux  
120x278 RT . 48"x109 1/2"

**FLOOR**  
Royal Beige lux  
120x120 RT . 48"x48"

**WALL**  
Royal Beige  
30,5x91,5 RT . 12"x36"  
Royal Beige struttura fluid  
30,5x91,5 RT . 12"x36"

**FLOOR**  
Calacatta lux  
75x75 RT . 30"x30"



# PARADISO

LUX



120x278 RT . 48"x109 1/2" ± 6 mm



120x120 RT . 48"x48" ± 9 mm

Distribuitor în România – Gada Ceramic București, Str. Vlad Juțețu 48  
Website: [www.gadaceramic.ro](http://www.gadaceramic.ro)

**La forte personalità della breccia paradiso, ha radici lontane ma rivive negli ambienti contemporanei, caratterizzandoli con una sofisticata eleganza dal fascino senza tempo.**

The strong personality of breccia paradiso has distant roots that are revived in contemporary settings, characterising them with a sophisticated elegance oozing timeless charm.

La forte personnalité de la breccia paradiso a des origines lointaines mais revit dans les espaces contemporains, leur donnant un certain cachet et une élégance sophistiquée au charme atemporel.

Die starke Persönlichkeit von Breccia Paradiso ist in der Vergangenheit verwurzelt, wird aber in Gegenwartsumgebungen zu neuem Leben erweckt, und füllt sie mit einer eleganten und zeitlosen Eleganz.



**WALL**  
Paradiso Lux  
120x278 RT . 48"x109 1/2"

**FLOOR**  
H. Ivory  
120x120 RT . 48"x48" serie H24



**WALL**  
Paradiso Lux  
120x278 RT . 48"x109 1/2"

**FLOOR**  
H. Ivory  
120x120 RT . 48"x48" serie H24

# ELEGANT GREIGE

## SILK



120x278 RT . 48"x109 1/2" ⇄ 6 mm

## LUX



120x278 RT . 48"x109 1/2" ⇄ 6 mm



120x120 RT . 48"x48" ⇄ 9 mm



75x150 RT . 30"x60" ⇄ 9 mm



75x75 RT . 30"x30" ⇄ 9 mm



60x120 RT . 24"x48" ⇄ 9 mm

## NATURALE . NATURAL



60x120 RT . 24"x48" ⇄ 9 mm

**In equilibrio tra passato e presente, Elegant Greige è un colore di tendenza che ripropone la purezza e l'eleganza del marmo, unendole alle caratteristiche di modernità e praticità del gres porcellanato.**

Perfectly positioned between past and present, Elegant Greige is a fashionable colour that reintroduces the purity and elegance of marble and combines it with the modernity and practicality of porcelain stoneware.

En équilibre entre le passé et le présent, Elegant Greige est une couleur tendance qui revisite la pureté et l'élégance du marbre, en les associant aux caractéristiques de modernité et de praticité du grès cérame.

Gleichgewicht zwischen Vergangenheit und Gegenwart, Elegant Greige heißt die trendige Farbe, die die Purheit und Eleganz von Marmor neu darstellt und mit den modernen Eigenschaften und der praktischen Anwendung von Feinsteinzeug vereint.



Elegant Greige Lux  
75x150 RT - 30"x60"



**WALL**  
Pure white lux  
120x278 RT - 48"x109 1/2"

**FLOOR**  
Elegant greige lux  
75x150 RT - 30"x60"

# PATAGONIA

## SILK



120x278 RT . 48"x109 1/2" ± 6 mm

## LUX



120x278 RT . 48"x109 1/2" ± 6 mm



120x120 RT . 48"x48" ± 9 mm



60x120 RT . 24"x48" ± 9 mm

## NATURALE . NATURAL



60x120 RT . 24"x48" ± 9 mm

Distribuitor în România – Gada Ceramic București, Str. Vlad Județu 48  
Website: [www.gadaceramic.ro](http://www.gadaceramic.ro)

**Una superficie dalla forte personalità per ambienti di sorprendente impatto visivo. Sfumature, riflessi, venature decise e profonde trasmettono un forte senso di unicità e definiscono ambienti originali capaci di dialogare con stili differenti. La superficie lux di PATAGONIA esalta la profondità della materia e diventa assoluta protagonista degli spazi.**

A surface with a strong personality for environments with surprising visual impact. Shades, reflections, sharp and deep veins convey a strong sense of uniqueness and define original environments capable of dialoguing with different styles. PATAGONIA's lux surface enhances the depth of the material and becomes the absolute star of the space.

Une surface à forte personnalité pour des espaces visuellement surprenants. Des nuances, des reflets et des veines marquées et profondes transmettent une forte sensation d'unicité et définissent des espaces originaux capables de dialoguer avec des styles différents. La surface brillante de PATAGONIA accentue la profondeur de la matière et devient l'atout incontestable des espaces.

Eine Oberfläche mit einer starken Persönlichkeit für Umgebungen mit überraschendem visuellem Eindruck. Schattierungen, Reflexionen, scharf umrissene und tiefe Maserungen vermitteln ein starkes Gefühl von Einzigartigkeit und definieren originelle Umgebungen, die mit verschiedenen Stilen kommunizieren können. Die Lux-Oberfläche von PATAGONIA akzentuiert die Tiefe des Materials und wird zum absoluten Mittelpunkt des Raumes.



**WALL**  
Patagonia Lux  
120x278 RT . 48"x109 1/2"

**FLOOR**  
Eden Lux  
120x120 RT . 48"x48"



**WALL**  
Patagonia Lux  
120x278 RT . 48"x109 1/2"

**FLOOR**  
Eden Lux  
120x120 RT . 48"x48"





**WALL**  
Patagonia lux  
120x278 RT . 48"x109 1/2"  
Serie Colovers: Love white  
120x278 RT . 48"x109 1/2"

**FLOOR**  
Patagonia Lux  
120x120 RT . 48"x48"

# GREEN CALACATTA

LUX



120x278 RT . 48"x109 1/2" ± 6 mm



120x120 RT . 48"x48" ± 9 mm

**Raffinate atmosfere pensate per l'interior design di ogni ambiente residenziale o commerciale. Dal fondo luminoso emergono venature marcate dalle mille sfumature che vanno dal beige al grigio, dal verde salvia allo smeraldo. Superfici lucide e scenografiche, per ambienti dal fascino intramontabile.**

Refined atmospheres for the interior design of any residential or commercial environment. Vivid veins emerge from the bright background in a thousand shades ranging from beige to grey, from sage green to emerald. Glossy, scenic surfaces for rooms with timeless appeal.

Des atmosphères raffinées pensées pour le design d'intérieur de n'importe quel espace résidentiel ou commercial. Du fond lumineux émergent des veines marquées aux mille nuances allant du beige au gris, du vert sauge à l'émeraude. Des surfaces brillantes et à fort impact, pour des espaces au charme durable.

Raffinierte Atmosphären, eigens für die Inneneinrichtung eines jeden Wohnbereichs oder gewerblichen Raums gestaltet. Aus dem hellen Hintergrund treten markante Maserungen in tausend Schattierungen hervor, von Beige bis Grau, von Salbeigrün bis Smaragdgrün. Glänzende Oberflächen in szenografischer Gestaltung für Räume mit zeitloser Ausstrahlung.



**WALL**  
Green Calacatta Lux  
120x278 RT . 48"x109 1/2"

**FLOOR**  
Green Calacatta Lux  
120x120 RT . 48"x48"



**WALL**  
Green Calacatta Lux  
120x278 RT . 48"x109 1/2"

**FLOOR**  
Green Calacatta Lux  
120x120 RT . 48"x48"

# OROBICA GRIGIA

## SILK



120x278 RT . 48"x109 1/2" ⇄ 6 mm

## LUX



120x278 RT . 48"x109 1/2" ⇄ 6 mm



120x120 RT . 48"x48" ⇄ 9 mm



75x150 RT . 30"x60" ⇄ 9 mm



75x75 RT . 30"x30" ⇄ 9 mm



60x120 RT . 24"x48" ⇄ 9 mm

## NATURALE . NATURAL



60x120 RT . 24"x48" ⇄ 9 mm

**Venature intense, sfumature naturali ed estetica raffinata caratterizzano la superficie dell'orobica grigia, rendendola protagonista assoluta degli ambienti.**

Intense veins, natural nuances and sophisticated styling distinguish the surface of orobica grigia, enabling it to play the absolute starring role of any setting.

Veines intenses, nuances naturelles et esthétique raffinée : telle est la surface de l'orobica grigia, qui se fait le protagoniste absolu des espaces.

Kräftige Maserungen, natürliche Farbnuancen und raffinierte Optik charakterisieren die Oberflächen von Orobica Grigia, und machen dieses Produkt zum absoluten Protagonisten im Ambiente.



### WALL

Orobica Grigia Lux  
120x278 RT . 48"x109 1/2"

### FLOOR

Orobica Grigia Lux  
120x278 RT . 48"x109 1/2"





**WALL**  
Orobica Grigia Lux  
120x278 RT . 48"x109 1/2"

**FLOOR**  
Orobica Grigia Lux  
120x120 RT . 48"x48"

# ONYX PEARL

## LUX

 120x120 RT . 48"x48" ÷ 9 mm

 75x150 RT . 30"x60" ÷ 9 mm

 75x75 RT. 30"x30" ÷ 9 mm

 60x120 RT . 24"x48" ÷ 9 mm

## NATURALE . NATURAL

 60x120 RT . 24"x48" ÷ 9 mm

**Sofisticato,  
originale, delicato:  
Onyx Pearl  
arreda gli spazi  
contemporanei  
caratterizzandoli  
con esclusiva  
eleganza.**

Sophisticated, original, delicate:  
Onyx Pearl enhances the  
contemporary interior, with a  
distinctive exclusive look.

Sophistiqué, original et délicat :  
Onyx Pearl décore les espaces  
contemporains tout en les  
caractérisant d'une esthétique  
exclusive.

Edel, originell, zart: Onyx  
Pearl richtet Räume mit  
zeitgenössischem Flair ein und  
charakterisiert sie mit einer  
exklusiven Ästhetik.

**WALL**  
Onyx Pearl lux  
120x120 RT . 48"x48"

**FLOOR**  
Onyx Pearl lux  
120x120 RT . 48"x48"





**WALL**  
Onyx Pearl lux  
120x120 RT . 48"x48"

**FLOOR**  
Onyx Pearl lux  
120x120 RT . 48"x48"

# SUPREME DARK

## LUX



120x278 RT . 48"x109 1/2" ⇄ 6 mm



120x120 RT . 48"x48" ⇄ 9 mm



75x150 RT . 30"x60" ⇄ 9 mm



75x75 RT . 30"x30" ⇄ 9 mm



60x120 RT . 24"x48" ⇄ 9 mm

## NATURALE . NATURAL



60x120 RT . 24"x48" ⇄ 9 mm

## Eleganza e fascino esaltate nel colore più scuro della gamma Purity of marble

Elegance and charm are emphasised with the Purity of marble range's darkest colour

Élégance et charme rehaussés dans la couleur la plus foncée de la gamme Purity of marble

Eleganz und Charme von der dunkelsten Farbe der Serie Purity of marble hervorgehoben



Supreme Dark lux  
120x278 RT - 48"x109 1/2"





**WALL**  
Supreme Dark lux  
120x278 RT - 48"X109 ½"

**FLOOR**  
Natural Blonde  
20x180 RT . 8"x72"  
Serie Natural Appeal



**WALL**  
Supreme Dark lux  
120x278 RT - 48"X109 1/2"  
Calacatta lux  
120x278 RT - 48"X109 1/2"

**FLOOR**  
Supreme Dark lux  
120x120 RT - 48"x48"



# BRECCIA NERA

## LUX



120x278 RT . 48"x109 1/2" ± 6 mm



120x120 RT . 48"x48" ± 9 mm



60x120 RT . 24"x48" ± 9 mm

## NATURALE . NATURAL



75x150 RT . 30"x60" ± 9 mm



75x75 RT . 30"x30" ± 9 mm

**La profondità della breccia nera e la sua raffinata eleganza, creano atmosfere uniche ed esclusive.**

The depth of breccia nera and its exclusive elegance create unique and exclusive atmospheres.

La profondeur de la breccia nera et son élégance exclusive créent des atmosphères uniques et spéciales.

Die Tiefe von Breccia Nera und seine exklusive Eleganz schaffen einzigartig exklusive Atmosphären.



**FLOOR**  
Breccia Nera Lux  
120x120 RT . 48"x48"



**FLOOR**  
Breccia Nera Lux  
120x120 RT . 48"x48"

# PRODUCT RANGE

## Purity of Marble

Statuario - Supreme Dark - Pure White -

Elegant Greige - Calacatta - Marfil ..... 120

Royal Beige - Lasa - Onyx Pearl ..... 122

## Purity of Marble Wall

Statuario - Marfil - Lasa - Calacatta -

Royal Beige ..... 124

## Purity of Marble Style

Arabescato - Crystal - Invisible Blue ..... 126

## Purity of Marble Élite

Eden - Patagonia - Green Calacatta ..... 128

## Purity of Marble Brecce

Paradiso - Capraia - Orobica Grigia -

Breccia Nera ..... 130

## Purity of Marble Tuscany

Mysterious White ..... 131

CERAMICHE  
SUPERGRES

**STATUARIO**

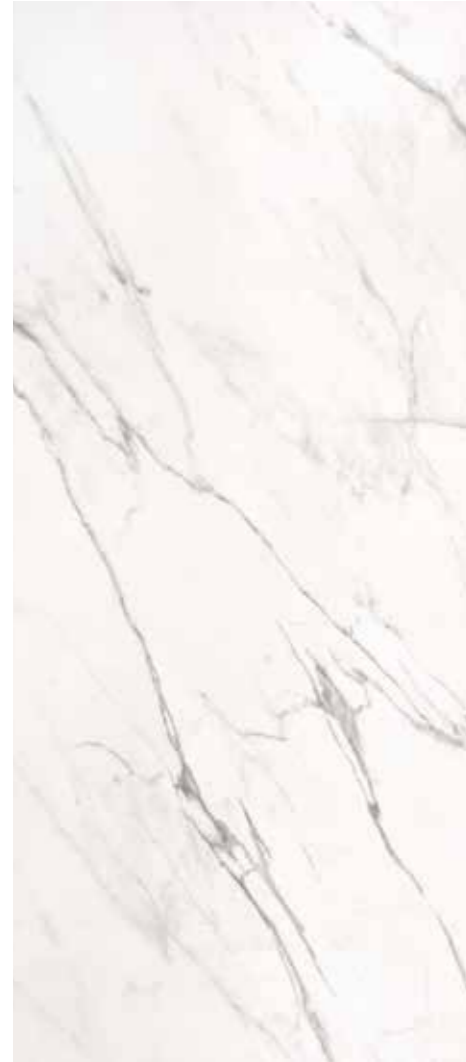

**SILK**  
120x278 RT . 48"x109 1/2" ➔ 6 mm

**LUX**  
120x278 RT . 48"x109 1/2" ➔ 6 mm  
120x120 RT . 48"x48" ➔ 9 mm  
75x150 RT . 30"x60" ➔ 9 mm  
\* 75x75 RT . 30"x30" ➔ 9 mm  
60x120 RT . 24"x48" ➔ 9 mm

**NATURALE**  
120x120 RT . 48"x48" ➔ 9 mm  
60x120 RT . 24"x48" ➔ 9 mm

**WALL**  
30,5x91,5 RT . 12"x36" ➔ 8,5 mm

**SUPREME DARK**



**LUX**  
120x278 RT . 48"x109 1/2" ➔ 6 mm  
120x120 RT . 48"x48" ➔ 9 mm  
75x150 RT . 30"x60" ➔ 9 mm  
\* 75x75 RT . 30"x30" ➔ 9 mm  
60x120 RT . 24"x48" ➔ 9 mm

**NATURALE**  
60x120 RT . 24"x48" ➔ 9 mm

**PURE WHITE**

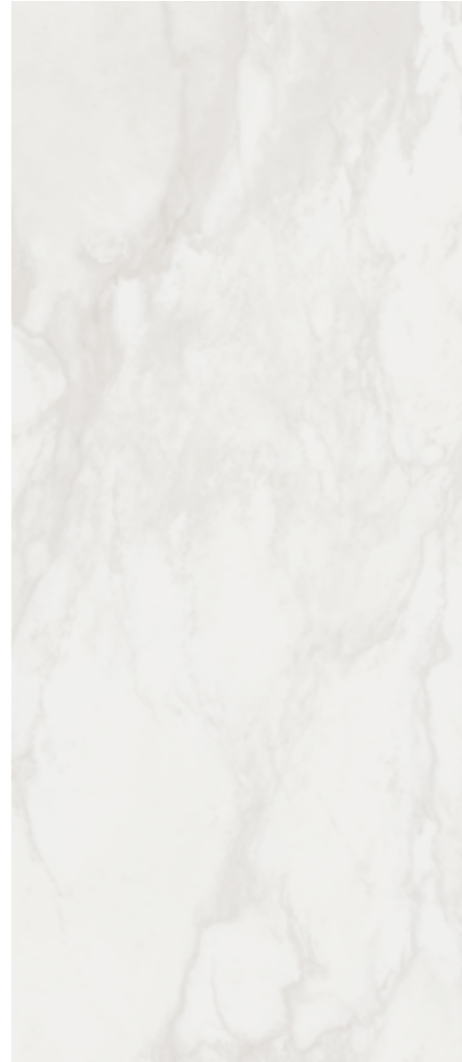

**SILK**  
120x278 RT . 48"x109 1/2" ➔ 6 mm

**LUX**  
120x278 RT . 48"x109 1/2" ➔ 6 mm  
120x120 RT . 48"x48" ➔ 9 mm  
75x150 RT . 30"x60" ➔ 9 mm  
\* 75x75 RT . 30"x30" ➔ 9 mm  
60x120 RT . 24"x48" ➔ 9 mm

**NATURALE**  
120x120 RT . 48"x48" ➔ 9 mm  
60x120 RT . 24"x48" ➔ 9 mm

**ELEGANT GREIGE**



**SILK**  
120x278 RT . 48"x109 1/2" ➔ 6 mm

**LUX**  
120x278 RT . 48"x109 1/2" ➔ 6 mm  
120x120 RT . 48"x48" ➔ 9 mm  
75x150 RT . 30"x60" ➔ 9 mm  
\* 75x75 RT . 30"x30" ➔ 9 mm  
60x120 RT . 24"x48" ➔ 9 mm

**NATURALE**  
60x120 RT . 24"x48" ➔ 9 mm

**CALACATTA**



**SILK**  
120x278 RT . 48"x109 1/2" ➔ 6 mm

**LUX**  
120x278 RT . 48"x109 1/2" ➔ 6 mm  
120x120 RT . 48"x48" ➔ 9 mm  
75x150 RT . 30"x60" ➔ 9 mm  
\* 75x75 RT . 30"x30" ➔ 9 mm  
60x120 RT . 24"x48" ➔ 9 mm

**NATURALE**  
120x120 RT . 48"x48" ➔ 9 mm  
60x120 RT . 24"x48" ➔ 9 mm

**WALL**  
30,5x91,5 RT . 12"x36" ➔ 8,5 mm

**MARFIL**



**SILK**  
120x278 RT . 48"x109 1/2" ➔ 6 mm

**LUX**  
120x120 RT . 48"x48" ➔ 9 mm  
75x150 RT . 30"x60" ➔ 9 mm  
\* 75x75 RT . 30"x30" ➔ 9 mm  
60x120 RT . 24"x48" ➔ 9 mm

**NATURALE**  
120x120 RT . 48"x48" ➔ 9 mm  
60x120 RT . 24"x48" ➔ 9 mm

**WALL**  
30,5x91,5 RT . 12"x36" ➔ 8,5 mm

**ROYAL BEIGE**



**LUX**

120x278 RT . 48"x109 1/2" ➔ 6 mm  
120x120 RT . 48"x48" ➔ 9 mm  
60x120 RT . 24"x48" ➔ 9 mm

**NATURALE**

60x120 RT . 24"x48" ➔ 9 mm

**WALL**

30,5x91,5 RT . 12"x36" ➔ 8,5 mm

**LASA**



**LUX**

120x120 RT . 48"x48" ➔ 9 mm  
75x150 RT . 30"x60" ➔ 9 mm  
\* 75x75 RT . 30"x30" ➔ 9 mm  
60x120 RT . 24"x48" ➔ 9 mm

**NATURALE**

60x120 RT . 24"x48" ➔ 9 mm

**WALL**

30,5x91,5 RT . 12"x36" ➔ 8,5 mm

**ONYX PEARL**



**LUX**

120x120 RT . 48"x48" ➔ 9 mm  
75x150 RT . 30"x60" ➔ 9 mm  
\* 75x75 RT . 30"x30" ➔ 9 mm  
60x120 RT . 24"x48" ➔ 9 mm

**NATURALE**

60x120 RT . 24"x48" ➔ 9 mm



Royal Beige Lux  
120x120 RT . 48"x48"

RIVESTIMENTO IN PASTA BIANCA . White body wall tiles . Revêtements en pâte blanche . Weißscherbiger wandfliesen

30,5x91,5 RT . 12"x36" ± 8,5mm

**STATUARIO**

**MARFIL**

**LASA**

**CALACATTA**

**ROYAL BEIGE**



STATUARIO 30,5x91,5 RT - 12"x36"



MARFIL 30,5x91,5 RT - 12"x36"



LASA 30,5x91,5 RT - 12"x36"



CALACATTA 30,5x91,5 RT - 12"x36"



ROYAL BEIGE 30,5x91,5 RT - 12"x36"



STATUARIO struttura FLUID  
30,5x91,5 RT - 12"x36"



MARFIL struttura FLUID  
30,5x91,5 RT - 12"x36"



LASA struttura FLUID  
30,5x91,5 RT - 12"x36"



CALACATTA struttura FLUID  
30,5x91,5 RT - 12"x36"



ROYAL BEIGE struttura FLUID  
30,5x91,5 RT - 12"x36"

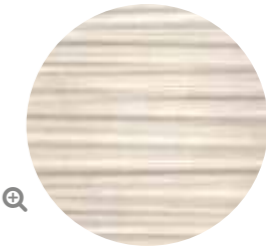

STATUARIO campitura RAMAGE  
30,5x91,5 RT - 12"x36"

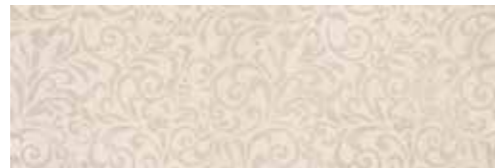

MARFIL campitura RAMAGE  
30,5x91,5 RT - 12"x36"

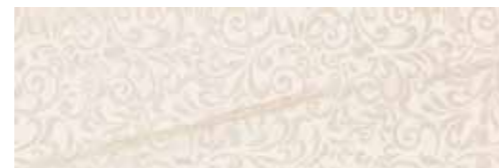

LASA campitura RAMAGE  
30,5x91,5 RT - 12"x36"



CALACATTA campitura RAMAGE  
30,5x91,5 RT - 12"x36"



ROYAL BEIGE campitura RAMAGE  
30,5x91,5 RT - 12"x36"



STATUARIO brick  
30,5x30,5 RT - 12"x12"



MARFIL brick  
30,5x30,5 RT - 12"x12"



LASA brick  
30,5x30,5 RT - 12"x12"



CALACATTA brick  
30,5x30,5 RT - 12"x12"



ROYAL BEIGE brick  
30,5x30,5 RT - 12"x12"



**Profili in metallo**

profilo metallo argento  
0,5x100 RT - 0,2"x40"

profilo metallo oro  
0,5x100 RT - 0,2"x40"

profilo metallo rame  
0,5x100 RT - 0,2"x40"



**ARABESCATO**



**SILK**  
120x278 RT . 48"x109 1/2" ➦ 6 mm

**LUX**  
120x278 RT . 48"x109 1/2" ➦ 6 mm  
120x120 RT . 48"x48" ➦ 9 mm  
75x150 RT . 30"x60" ➦ 9 mm  
\* 75x75 RT . 30"x30" ➦ 9 mm  
60x120 RT . 24"x48" ➦ 9 mm

**NATURALE**  
75x150 RT . 30"x60" ➦ 9 mm  
\* 75x75 RT . 30"x30" ➦ 9 mm  
60x120 RT . 24"x48" ➦ 9 mm

**CRYSTAL**



**SILK**  
120x278 RT . 48"x109 1/2" ➦ 6 mm

**LUX**  
120x278 RT . 48"x109 1/2" ➦ 6 mm  
120x120 RT . 48"x48" ➦ 9 mm  
75x150 RT . 30"x60" ➦ 9 mm  
\* 75x75 RT . 30"x30" ➦ 9 mm  
60x120 RT . 24"x48" ➦ 9 mm

**NATURALE**  
120x120 RT . 48"x48" ➦ 9 mm  
75x150 RT . 30"x60" ➦ 9 mm  
\* 75x75 RT . 30"x30" ➦ 9 mm  
60x120 RT . 24"x48" ➦ 9 mm

**INVISIBLE BLUE**



**LUX**  
120x278 RT . 48"x109 1/2" ➦ 6 mm  
120x120 RT . 48"x48" ➦ 9 mm  
75x150 RT . 30"x60" ➦ 9 mm  
\* 75x75 RT . 30"x30" ➦ 9 mm  
60x120 RT . 24"x48" ➦ 9 mm

**NATURALE**  
75x150 RT . 30"x60" ➦ 9 mm  
\* 75x75 RT . 30"x30" ➦ 9 mm

FLOOR  
Crystal Lux 120x120 RT . 48"x48"

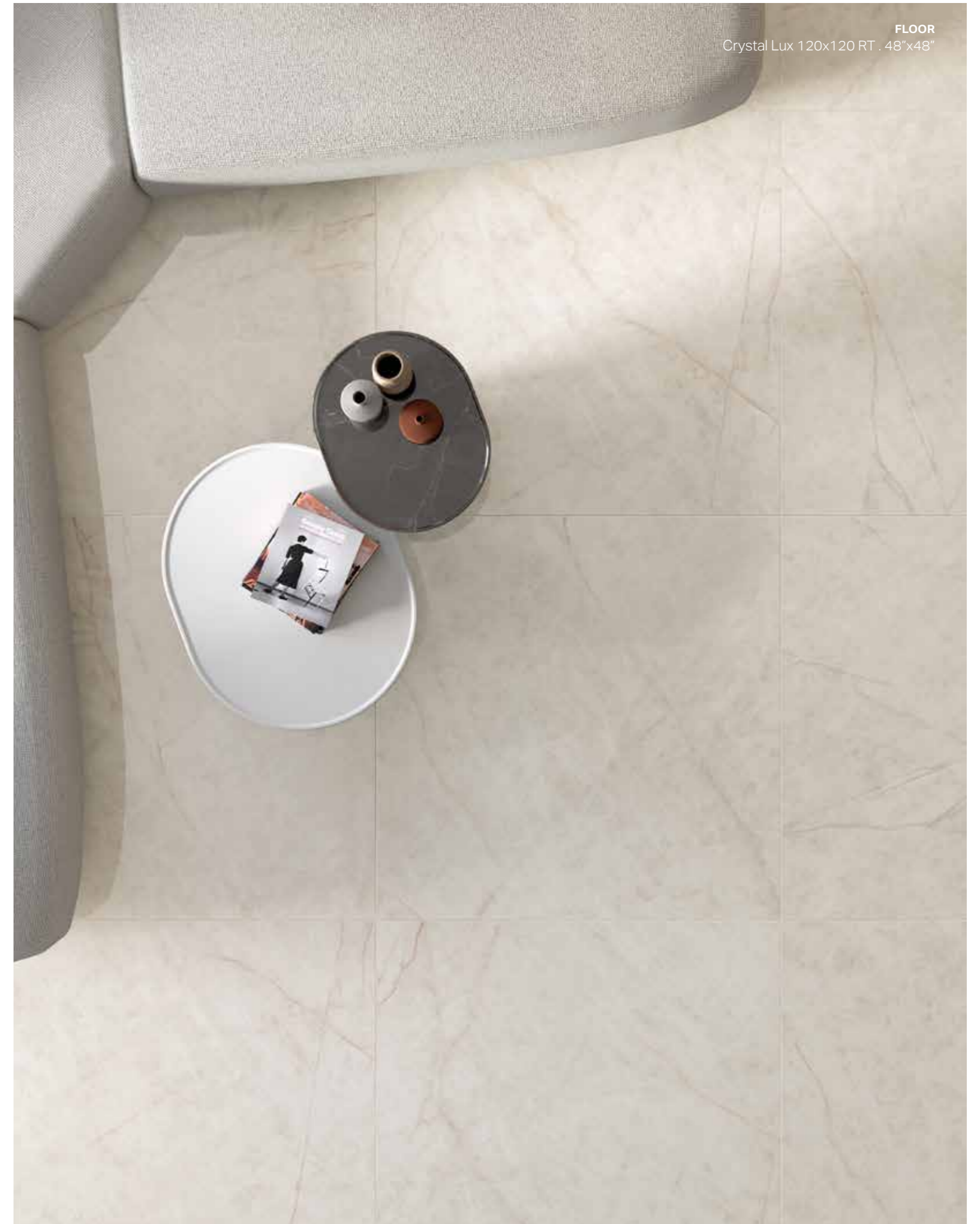

**EDEN**



**SILK**

120x278 RT . 48"x109 1/2" ➦ 6 mm

**LUX**

120x278 RT . 48"x109 1/2" ➦ 6 mm

120x120 RT . 48"x48" ➦ 9 mm

75x150 RT . 30"x60" ➦ 9 mm

\* 75x75 RT . 30"x30" ➦ 9 mm

60x120 RT . 24"x48" ➦ 9 mm

**NATURALE**

120x120 RT . 48"x48" ➦ 9 mm

75x150 RT . 30"x60" ➦ 9 mm

\* 75x75 RT . 30"x30" ➦ 9 mm

60x120 RT . 24"x48" ➦ 9 mm

**PATAGONIA**



**SILK**

120x278 RT . 48"x109 1/2" ➦ 6 mm

**LUX**

120x278 RT . 48"x109 1/2" ➦ 6 mm

120x120 RT . 48"x48" ➦ 9 mm

60x120 RT . 24"x48" ➦ 9 mm

**NATURALE**

60x120 RT . 24"x48" ➦ 9 mm

**GREEN CALACATTA**



**LUX**

120x278 RT . 48"x109 1/2" ➦ 6 mm

120x120 RT . 48"x48" ➦ 9 mm



Patagonia lux  
120x278 RT . 48"x109 1/2"

**FLOOR**  
Patagonia Lux  
120x120 RT . 48"x48"

**PARADISO**



**LUX**

120x278 RT . 48"x109 1/2" ⇄ 6 mm  
120x120 RT . 48"x48" ⇄ 9 mm

**CAPRAIA**



**SILK**

120x278 RT . 48"x109 1/2" ⇄ 6 mm

**LUX**

120x120 RT . 48"x48" ⇄ 9 mm  
60x120 RT . 24"x48" ⇄ 9 mm

**NATURALE**

60x120 RT . 24"x48" ⇄ 9 mm

**OROBICA GRIGIA**



**SILK**

120x278 RT . 48"x109 1/2" ⇄ 6 mm

**LUX**

120x278 RT . 48"x109 1/2" ⇄ 6 mm  
120x120 RT . 48"x48" ⇄ 9 mm  
75x150 RT . 30"x60" ⇄ 9 mm  
\* 75x75 RT . 30"x30" ⇄ 9 mm  
60x120 RT . 24"x48" ⇄ 9 mm

**NATURALE**

60x120 RT . 24"x48" ⇄ 9 mm

**BRECCIA NERA**



**LUX**

120x278 RT . 48"x109 1/2" ⇄ 6 mm  
120x120 RT . 48"x48" ⇄ 9 mm  
60x120 RT . 24"x48" ⇄ 9 mm

**NATURALE**

\* 75x150 RT . 30"x60" ⇄ 9 mm  
75x75 RT . 30"x30" ⇄ 9 mm

**MYSTERIOUS WHITE**



**LUX**

120x278 RT . 48"x109 1/2" ⇄ 6 mm  
120x120 RT . 48"x48" ⇄ 9 mm  
75x150 RT . 30"x60" ⇄ 9 mm  
\* 75x75 RT . 30"x30" ⇄ 9 mm  
60x120 RT . 24"x48" ⇄ 9 mm

# Vein matching

Per numerosi articoli di Purity of marble è possibile posare le lastre con disegno continuo tra un pezzo e l'altro, come nei marmi più pregiati (vein matching). L'inserimento delle lastre nelle confezioni è casuale, pertanto Supergres non garantisce le tipologie di facce presenti all'interno di ogni singola confezione.

Il set vein matching è una composizione delle 4 o 5 diverse lastre con vena continua. Ordinando il set vein matching, il cliente ha la garanzia di ricevere le lastre numerate, che, posate nella sequenza indicata nello schema esemplificativo riportato di seguito, permette di ottenere un risultato estetico di altissimo livello. Per ricostruire la vena continua tra un pezzo e il successivo, è sufficiente posare le lastre in progressione numerica dalla n° 1 alla n° 4 (o 5). Per mantenere la continuità della vena, dopo la faccia n° 4 (o 5) occorre ripartire con la faccia n° 1. La continuità della vena si riferisce al lato 278.

Many articles in the Purity of Marble range can be installed with vein matching (continuity of vein between slabs) to produce unbroken patterning on the wall, as with the finest marbles. The order in which the slabs are packed is random, so Supergres does not guarantee the types of faces found in each individual pack. The VEIN MATCHING SET is a composition of four (or five) different slabs with continuous vein. Ordering the vein matching set, the customer receives 4 (or 5) numbered slabs. When installed according to the layout indicated as an example, a highly performing aesthetic result is achieved. To form the continuous vein between one piece and the following, just install the slabs progressively from number 1 to 4 (or 5). To maintain the continuity of the vein, after face 4 (or 5), face 1 must be started again. Continuity of the vein refers to side 278.

Pour la plupart des articles de Purity of marble, les dalles peuvent se poser avec un motif continu entre chaque pièce, comme dans les marbres les plus nobles.(vein matching). Les dalles étant placées dans les boîtes de façon aléatoire, Supergres ne garantit pas les types de faces à l'intérieur de chaque boîte.

Le set vein matching, est une composition de 4 ou 5 dalles différentes avec veine continue. En commandant le set vein matching, le client est assuré de recevoir les dalles numérotées qui, lorsqu'elles sont posées dans l'ordre indiqué dans l'exemple de plan de pose ci-dessous, permettent d'obtenir un rendu esthétique de très haut niveau. Pour reconstituer la veine continue d'une pièce à l'autre, il suffit de poser les dalles dans l'ordre numérique, de la n° 1 à la n° 4 (ou 5). Pour maintenir la continuité de la veine, après la face n° 4 (ou 5), il faut recommencer avec la face n° 1. La continuité de la veine concerne le côté 278.

Bei vielen Purity of marble-Artikeln besteht die Möglichkeit, die Platten mit durchgängiger Äderung zwischen einer Platte und der nächsten zu verlegen, wie bei den edelsten Marmorsteinen (vein matching). Die Platten werden beliebig in die Konfektionen eingegliedert. Supergres übernimmt daher keine Garantie dafür, dass die Plattentypen in jeder einzelnen Kollektion verfügbar sind. Das Vein matching-Set ist ein Sortiment aus 4 oder 5 unterschiedlichen Platten mit durchgängiger Äderung.

Mit der Bestellung des Vein matching-Sets hat der Kunde die Gewähr, nummerierte Platten zu erhalten, die bei Verlegung in der im nachstehenden Verlegemusterbeispiel angegebenen Reihenfolge ein hochkarätiges ästhetisches Ergebnis ermöglichen. Zur Rekonstruktion der durchgängigen Äderung zwischen einer Platte und der nächsten müssen die Platten nur in der Reihenfolge von Nr. 1 bis Nr. 4 (oder 5) verlegt werden. Zur Fortsetzung des durchgängigen Verlaufs der Äderung muss man nach der Platte Nr. 4 (oder 5) wieder mit der Platte Nr. 1 beginnen. Die durchgängige Äderung bezieht sich auf die Seite 278

- Eventuali disallineamenti tra le venature sono da considerarsi caratteristica intrinseca del prodotto.
- L'immagine rappresentata serve a dare un'idea indicativa del prodotto, toni e venature possono essere quindi suscettibili di variazioni.

- Any mismatches between vein patterns should be considered to be intrinsic characteristics of the product.
- The image shown is designed to provide an indicative idea of the product, the colours and vein patterns may therefore vary.

- Les éventuels désalignements entre les veines doivent être considérés comme une caractéristique intrinsèque du produit.
- L'image représentée sert à donner une idée indicative du produit ; les teintes et les veines peuvent donc être susceptibles de variations.

- Jede Abweichung zwischen den Maserungen ist eine inhärente Eigenschaft des Produkts.

- Das Bild liefert eine ungefähre Darstellung des Produkts; Farbtöne und Maserungen können daher abweichen.

# Vein matching

PURITY OF MARBLE - STYLE

## Crystal Lux e Silk 120x278 RT



## Arabescato Lux e Silk 120x278 RT



## Invisible Blue Lux 120x278 RT

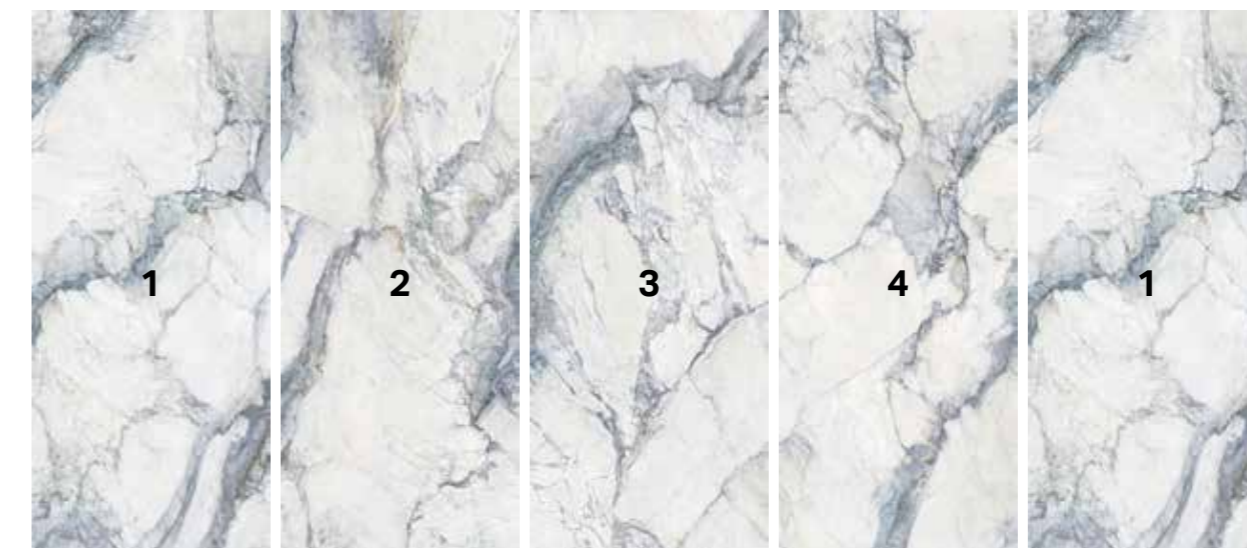

# Vein matching

PURITY OF MARBLE

**Statuario Lux e Silk** 120x278 RT

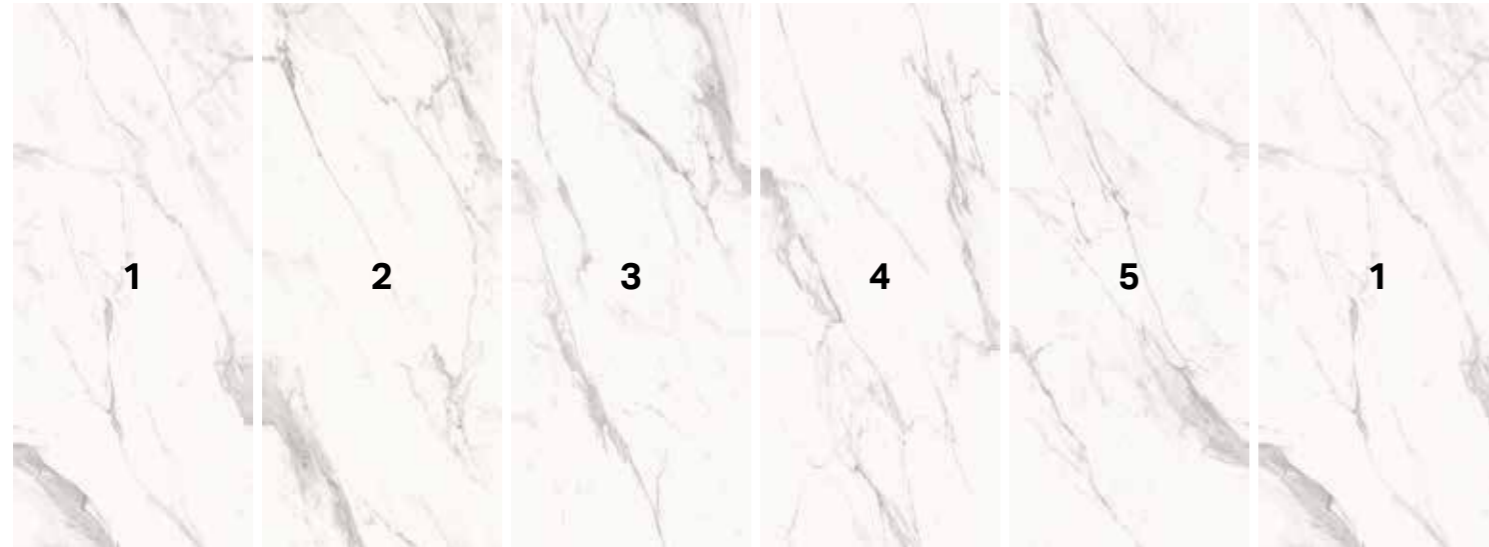

**Supreme Dark Lux** 120x278 RT

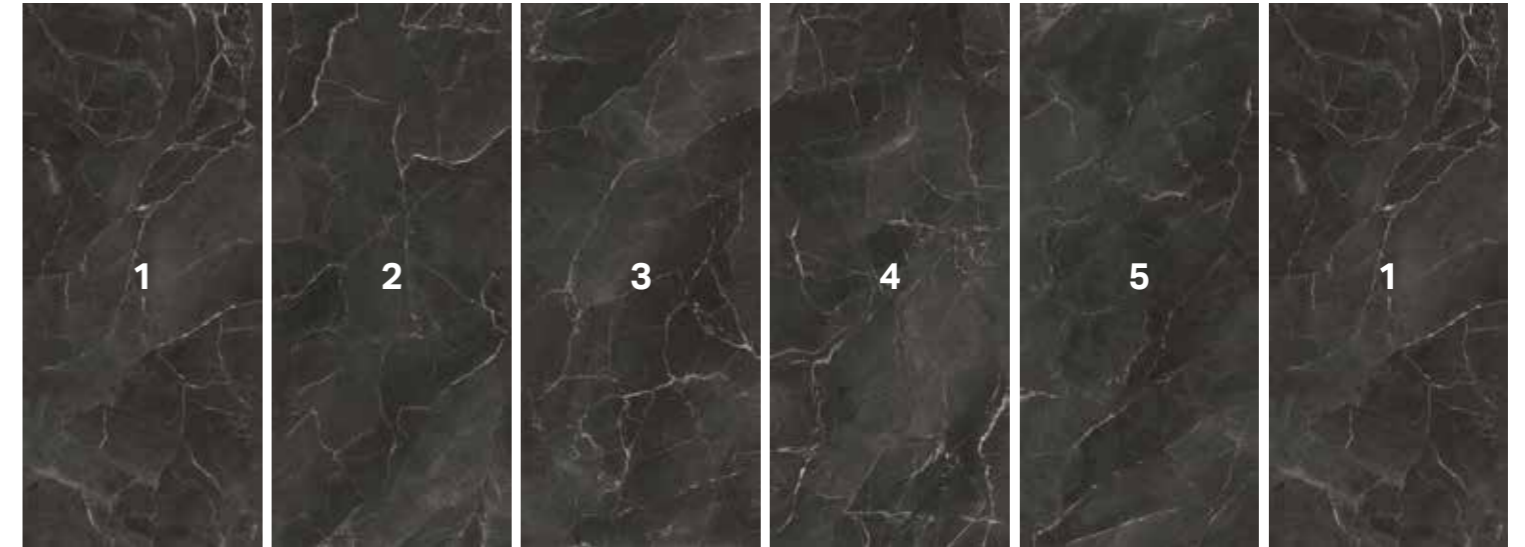

**Elegant Greige Lux e Silk** 120x278 RT



**Calacatta Lux e Silk** 120x278 RT

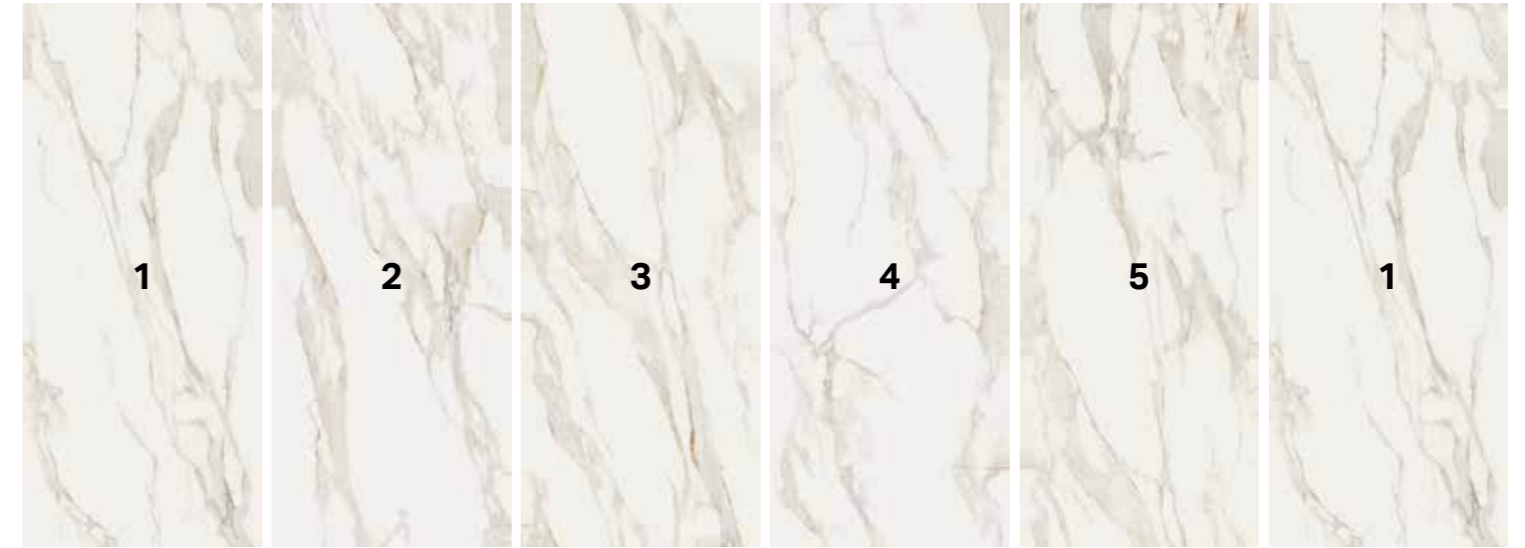

**Royal Beige Lux** 120X278 RT

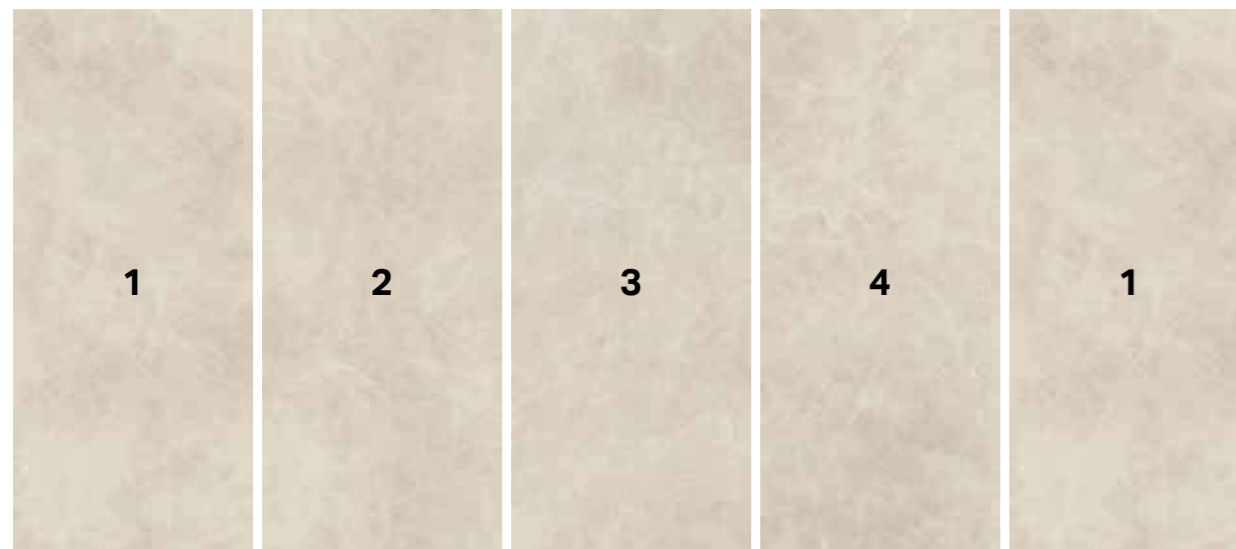

- Eventuali disallineamenti tra le venature sono da considerarsi caratteristica intrinseca del prodotto.
- L'immagine rappresentata serve a dare un'idea indicativa del prodotto, toni e venature possono essere quindi suscettibili di variazioni.
- Any mismatches between vein patterns should be considered to be intrinsic characteristics of the product.
- The image shown is designed to provide an indicative idea of the product, the colours and vein patterns may therefore vary.
- Les éventuels désalignements entre les veines doivent être considérés comme une caractéristique intrinsèque du produit.
- L'image représentée sert à donner une idée indicative du produit ; les teintes et les veines peuvent donc être susceptibles de variations.
- Jede Abweichung zwischen den Maserungen ist eine inhärente Eigenschaft des Produkts.
- Das Bild liefert eine ungefähre Darstellung des Produkts; Farbtöne und Maserungen können daher abweichen.

# Vein matching

## PURITY OF MARBLE - ÉLITE

### Eden Lux e Silk 120x278 RT



### Patagonia Lux e Silk 120x278 RT

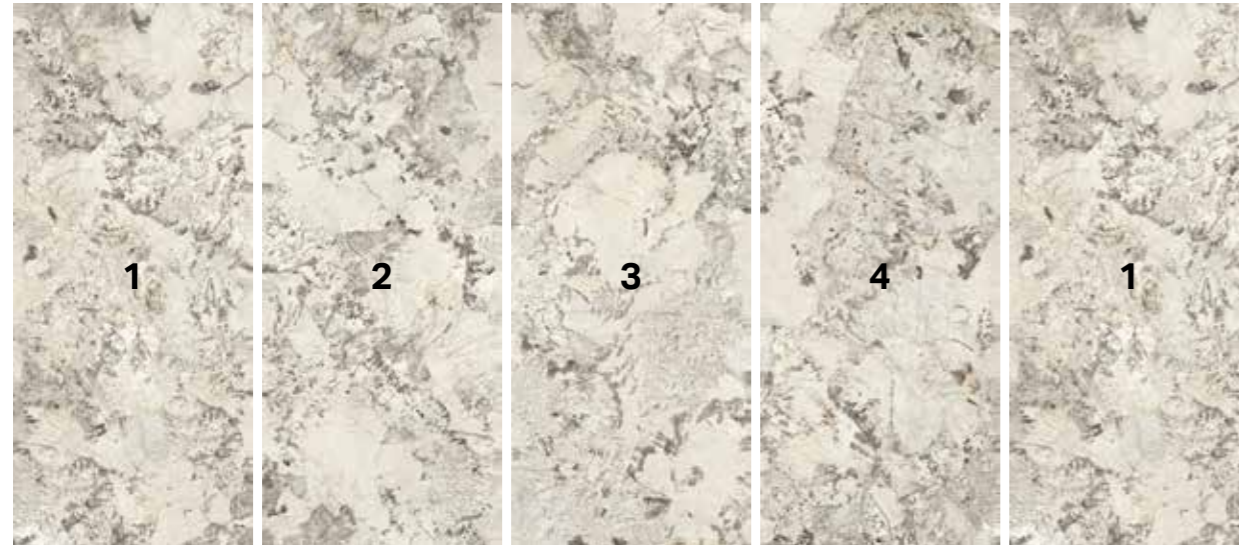

### Green Calacatta Lux 120x278 RT

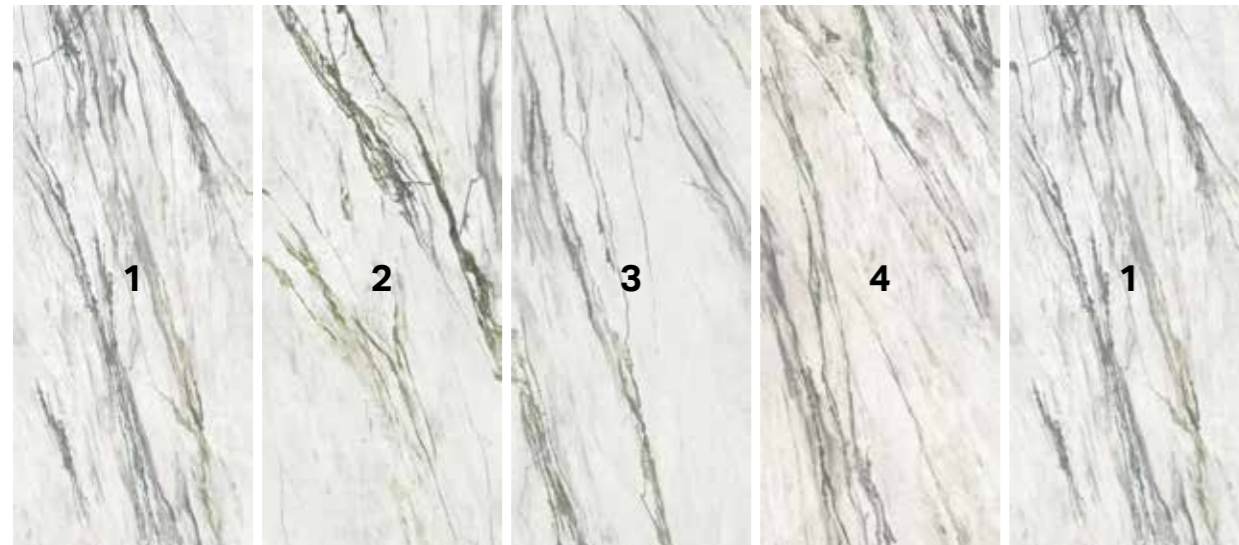

## PURITY OF MARBLE - TUSCANY

### Mysterious white Lux 120x278 RT

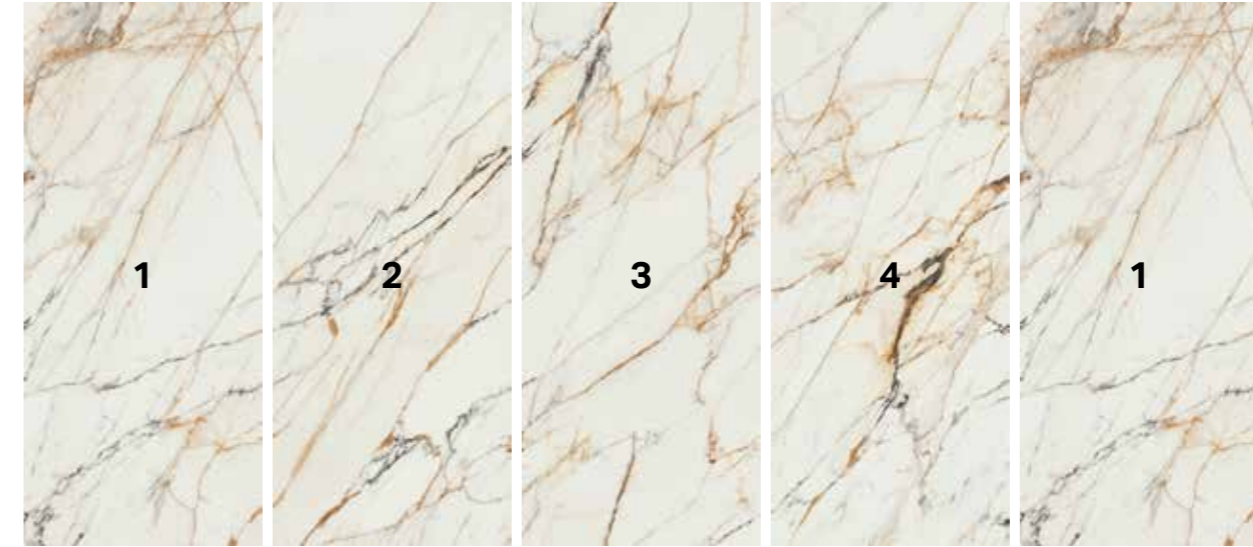

- Eventuali disallineamenti tra le venature sono da considerarsi caratteristica intrinseca del prodotto.
- L'immagine rappresentata serve a dare un'idea indicativa del prodotto, toni e venature possono essere quindi suscettibili di variazioni.
- Any mismatches between vein patterns should be considered to be intrinsic characteristics of the product.
- The image shown is designed to provide an indicative idea of the product, the colours and vein patterns may therefore vary.
- Les éventuels désalignements entre les veines doivent être considérés comme une caractéristique intrinsèque du produit.
- L'image représentée sert à donner une idée indicative du produit ; les teintes et les veines peuvent donc être susceptibles de variations.
- Jede Abweichung zwischen den Maserungen ist eine inhärente Eigenschaft des Produkts.
- Das Bild liefert eine ungefähre Darstellung des Produkts; Farbtöne und Maserungen können daher abweichen.













## PURITY OF MARBLE - BRECCE

### Capraia Silk 120x278 RT



# Tabella riassuntiva formati e finiture

Summary of sizes and finishes - Übersicht über Formate und Oberfläche - Récapitulatif formats et surfaces

		Purity of Marble - STYLE			Purity of Marble - ÉLITE			TUSCANY	Purity of Marble										Purity of Marble - BRECCIE			
		ARABESCATO	CRYSTAL	INVISIBLE BLUE	PATAGONIA	EDEN	GREEN CALACATTA	MYSTERIOUS WHITE	STATUARIO	CALACATTA	ELEGANT GREIGE	PURE WHITE	SUPREME DARK	LASA	ONYX PEARL	MARFIL	ROYAL BEIGE	CAPRAIA	OROBICA GRIGIA	BRECCIA NERA	PARADISO	
GRES PORCELLANATO . Porcelain stoneware																						
<b>SILK</b>																						
6 mm		120x278 RT	■	■		■	■				■	■	■	■			■		■	■		
<b>LUX</b>																						
6 mm		120x278 RT	■	■	■	■	■	■	■				■							■	■	■
<b>LUX</b>																						
9 mm		120x120 RT	■	■	■	■	■	■	■				■	■	■	■	■	■	■	■	■	
		60x120 RT	■	■	■	■	■	■	■				■	■	■	■	■	■	■	■	■	
		75x150 RT	■	■	■		■	■	■				■	■	■	■	■		■		■	
		75x75 RT *	■	■	■		■	■	■				■	■	■	■	■		■		■	
<b>NATURALE NATURAL</b>																						
9 mm		120x120 RT		■			■					■				■						
		60x120 RT	■	■		■	■					■	■	■	■	■	■	■	■	■	■	
		75x150 RT	■	■	■		■														■	
		75x75 RT *	■	■	■		■														■	
RIVESTIMENTO IN PASTA BIANCA . White body wall tiles																						
<b>RIVESTIMENTI WALL</b>																						
8,5 mm		30,5x91,5 RT																				
		30,5x91,5 RT Struttura FLUID																				

\* su richiesta / on demand

CERAMICHE  
SUPERGRES

# Avvertenze per la posa

Recommendations for installation.

Recommandations pour la pose.

Verlegetipps.

Per la posa del materiale rettificato si consiglia una fuga minima di 2 mm.

As for rectified materials, it is strongly recommended a minimum of 2 mm joint.

Pour poser du matériel rectifié nous vous conseillons un joint minimum de 2 mm.

Für die Verlegung des kalibrierten Material empfehlen wir einen Mindestfuge von 2 mm.

La finitura superficiale "LUX" è una nuova tecnica di lappatura di ceramiche Supergres, caratterizzata da una superficie a lappatura integrale che esalta i dettagli della grafica. Le piccole picchiettature, le discontinuità e le leggere ondulazioni della superficie del prodotto sono volute per riprodurre fedelmente l'aspetto reale delle pietre e dei marmi antichi levigati donando al prodotto un aspetto ancora più naturale. La finitura LUX è consigliata per l'utilizzo a pavimento negli ambienti residenziali e negli ambienti dove non siano richieste delle particolari prestazioni antiscivolo. Per le sue caratteristiche, la finitura LUX è raccomandata solo in ambienti interni e non a diretto contatto con l'esterno, in modo da preservare la brillantezza della superficie

The "LUX" surface finish is a new honing technique by Ceramiche Supergres that sets itself apart thanks to an integral honing on the surface that exalts the graphic details. The light speckles, the random effect and slight waves on the surface of the product are intentional and created to faithfully reproduce the aspect of age-old polished stones and marble, giving the product an even more natural look. The LUX surface finish is recommended for floor application in residential venues and in locations where special anti-slip performance is not required. Due to these features, in order to maintain the brilliance of the LUX surface finish, it is only suitable for indoor use and not for use in direct contact with outdoor areas.

La finition superficielle "LUX" est une nouvelle technique de rodage de ceramiche Supergres, caractérisée par une surface intégralement rodée qui exalte les détails du graphisme. Les petites tiquettes, les discontinuités et les légères ondulations de la surface du produit sont réalisées pour reproduire fidèlement l'aspect réel des pierres et des marbres antiques polis, en donnant au produit un aspect encore plus naturel. La finition LUX est conseillée pour l'application au sol dans les espaces résidentiels et dans les espaces qui n'exigent pas la finition antidérapante. Pour ses caractéristiques, la finition LUX est conseillée seulement pour des espaces intérieurs qui ne sont pas en contact direct avec l'extérieur, de façon à préserver l'éclat de la surface.

Die Oberfläche "LUX" wird aufgrund einer neuen Lapptechnik von Ceramiche Supergres erhalten und kennzeichnet sich durch integral geläppte Oberflächen, wodurch die Details der Grafiken besonders hervorgehoben werden. Die kleinen Sprengel, die Diskontinuitäten und die sanften Wellen der Oberfläche des Produkts sind gewollt und ahmen naturgetreu das wirkliche Aussehen der Natursteine und der polierten, antiken Marmorarten nach, während sie dadurch dem Produkt eine noch natürlichere Optik verleihen. Die Oberfläche LUX ist für den Einsatz als Fußboden in Wohnambientes und in Umgebungen, in denen keine speziellen rutschhemmenden Leistungen erforderlich sind empfohlen. Aufgrund ihrer Eigenschaften ist die Oberfläche LUX nur für Innenräume geeignet, die nicht in direktem Kontakt mit dem Außenbereich kommen, so dass der Glanz der Oberfläche erhalten bleibt.



Supergres raccomanda l'utilizzo a pavimento di lastre in spessore 6 mm per le sole applicazioni in ambito residenziale, commerciale a traffico leggero e comunque in contesti ove non vi sia passaggio di carichi puntuali pesanti o transito di carrelli a ruote dure.

Le lastre a 6 mm, grazie al loro spessore ridotto, sono particolarmente indicate per la posa su pavimenti o rivestimenti preesistenti in marmo, pietra naturale, ceramica, senza la necessità di demolire la pavimentazione sottostante. Tale pavimentazione preesistente dovrà però essere planare, stabile, rigida e priva di rotture. In tutti questi casi sarà necessario valutare attentamente, assieme al progettista della pavimentazione, l'idoneità del sottofondo. In caso di dubbio sarà necessario valutare la necessità della demolizione e/o l'utilizzo di spessori tradizionali.

Supergres sconsiglia la posa delle lastre in 6 mm di spessore direttamente su massetto in quanto tale applicazione è fortemente condizionata dall'esecuzione ottimale del massetto stesso, dalla sua completa stagionatura, dal rispetto degli opportuni giunti di dilatazione nonché dalla posa effettuata a "regola d'arte". Pertanto in caso di posa diretta su massetto, Supergres suggerisce l'utilizzo del gres porcellanato a spessore tradizionale. In generale, per l'applicazione a pavimento delle lastre in spessore 6 mm, l'adesivo (da scegliere insieme al progettista in base alle caratteristiche del cantiere) dovrà essere applicato secondo il metodo della doppia spalmatura, al fine di assicurare la perfetta distribuzione dello stesso e di garantire un'adesione ottimale, evitando la formazione di eventuali vuoti che potrebbero essere causa di rotture.

Supergres stresses that slabs 6 mm in thickness may only be used as flooring in residential and commercial environments that are subject to light traffic, and furthermore, in contexts where there is no circulation of heavy loads or hard-tyre trolleys.

Thanks to the reduced thickness, the 6 mm slabs are a good solution for laying over pre-existing floors or tiling in marble, natural stone or ceramics, and avoid the necessity of demolishing the underlying floor. Such preexisting flooring must, however, be even, stable, rigid and without breakages. Even if the floor conforms to all the above conditions, it is still necessary, together with the flooring project manager, to evaluate the suitability of the underlying layer. If there are any doubts, the need for demolition and/or the use of traditional thickness must be evaluated.

Supergres does not recommend the installation of 6 mm thickness on a slab since the results of installation strictly relate to the condition - excellent - of the slab, to its seasoning, to the provision of expansion joints, as well as to perfect installation in accordance to "the rules of the trade". If you are tiling a new slab, Supergres recommends the use of porcelain stoneware with a standard thickness.

In general, when laying a floor of 6 mm thick slabs, the adhesive (to be selected together with the project manager based on the characteristics of the construction) must be applied using the double bonding technique, aimed at ensuring the perfect distribution of the adhesive to guarantee the best bond, avoiding the presence of any hollows that could cause breakages.

Supergres recommande l'utilisation au sol de plaques de 6 mm d'épaisseur uniquement pour des applications dans un contexte résidentiel et commercial à faible affluence ainsi que dans des contextes dépourvus de passages de charges ponctuelles lourdes ou de chariots à roues dures.

Les plaques de 6 mm d'épaisseur, grâce à leur épaisseur réduite, sont particulièrement adaptées à une pose sur des sols ou des revêtements préexistants en marbre, en pierre naturelle et en céramique, sans impliquer la démolition de la sous-couche. Cette sous-couche préexistante devra toutefois être plane, stable, rigide et privée de ruptures. Il sera dans tous les cas nécessaire d'évaluer attentivement, avec le concepteur du sol, la conformité de la sous-couche. En cas de doute, il sera nécessaire d'évaluer la nécessité de la démolition et/ou l'utilisation d'épaisseurs traditionnelles. Supergres déconseille la pose directe de plaques de 6mm d'épaisseur sur une chape car le résultat dépend de la bonne exécution de la chape, de son séchage complet, du respect des joints de dilatation ainsi que de la pose effectuée selon les règles de l'art. Par conséquent, pour une pose directe sur une chape, Supergres préconise un carrelage en grès cérame d'une épaisseur traditionnelle.

En général, pour l'application au sol des plaques de 6 mm d'épaisseur, l'adhésif (à choisir avec le concepteur en fonction des caractéristiques du chantier) devra être appliqué suivant la méthode du double encollage afin de garantir non seulement la répartition parfaite de ce dernier mais aussi une adhérence optimale, en évitant ainsi la formation de vides éventuels qui pourrait provoquer des ruptures.

Supergres empfiehlt die Verwendung von Platten mit Stärke 6 mm als Bodenbelag nur für Anwendungen im Privatbereich und in Gewerbe- und Objektbereichen mit geringer Trittbelastung, oder in Bereichen, in denen zumindest keine Rollwagen mit harten Rädern zum Einsatz kommen oder schwere punktuelle Belastungen auftreten.

Die 6 mm starken Platten eignen sich aufgrund ihrer geringen Stärke besonders für die Verlegung auf bestehenden Bodenbelägen oder Wandverkleidungen aus Marmor, Naturstein, Keramik, ohne dass der darunterliegende Belag zuvor entfernt werden muss. Dieser bereits vorhandene Boden muss jedoch eben, stabil, hart und bruchstabil sein. In all diesen Fällen muss die Eignung des Untergrundes gemeinsam mit dem Architekten oder Planer zuvor sorgfältig geprüft werden. Im Zweifelsfall muss die Notwendigkeit einer Entfernung des bestehenden Bodenbelags und/oder die Verwendung herkömmlicher Stärken in Erwägung gezogen werden.

Supergres rät davon ab, 6mm starken Platten direkt auf Estrich zu verlegen, da eine solche Anwendung stark von einer optimalen Anfertigung des Estrichs selbst abhängig ist, sowie von seiner kompletten Belegreife, der Einhaltung der notwendigen Dehnungsfugen, sowie von einer „fachgerechten“ Verlegung. Deshalb empfiehlt Supergres im Falle einer direkten Verlegung auf Estrich, Steinzeug mit traditioneller Dicke zu verwenden.

Im Allgemeinen muss bei der Verlegung von 6 mm starken Platten als Bodenbelag der Klebstoff (der zusammen mit dem Planer nach den Eigenschaften des Verwendungsorts ausgewählt wird) doppelt aufgetragen werden (sowohl auf dem Untergrund als auch auf der Rückseite der Platte), um eine perfekte Verteilung und eine optimale Haftung zu gewährleisten und die Bildung von Hohlräumen zu vermeiden, die zu Bruch führen könnten.



# Pezzi Speciali

Trims  
Pièces Spéciales  
Formstücke

## Finitura Naturale

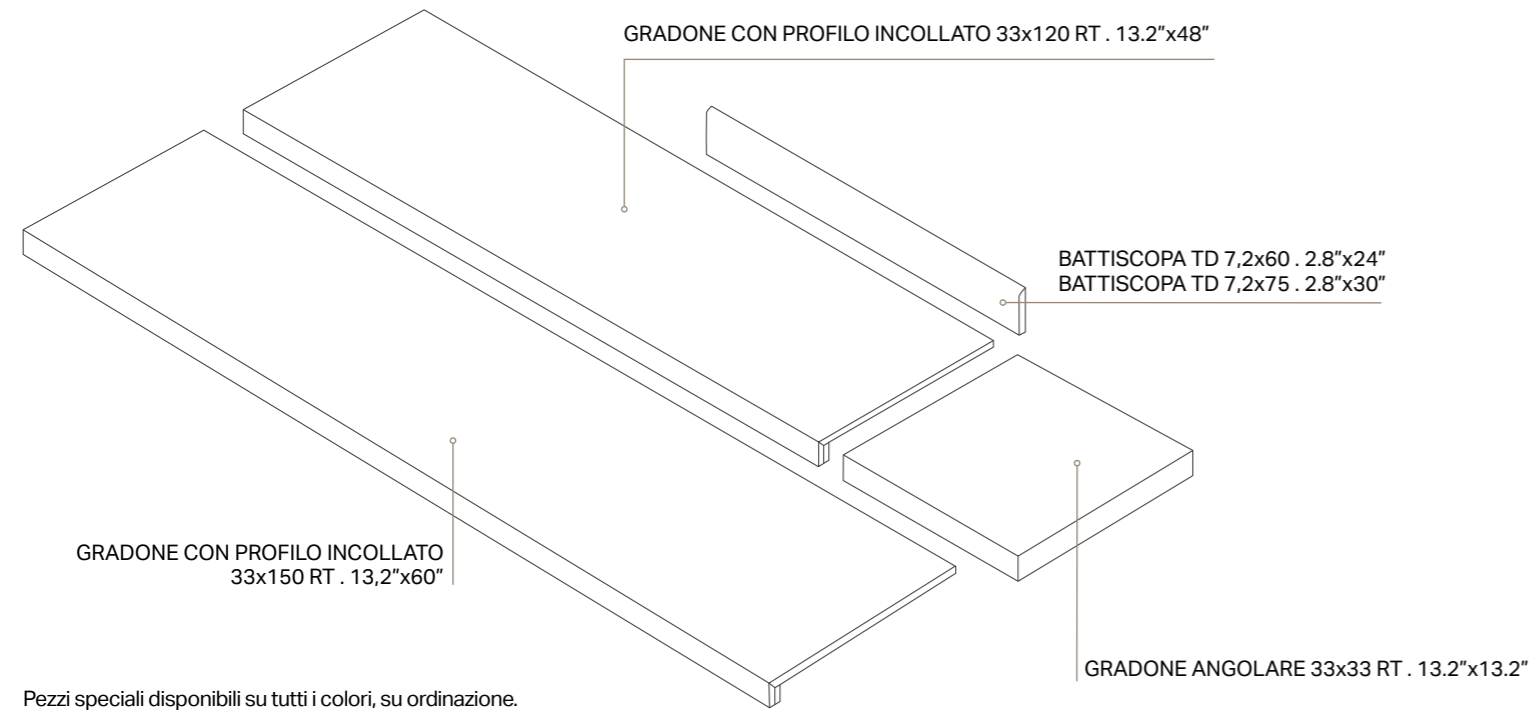

Pezzi speciali disponibili su tutti i colori, su ordinazione.  
Trim tiles available in all colors, to order.  
Pièces spéciales disponibles dans toutes les couleurs, sur demande.  
Formteile auf Bestellung in allen Farben verfügbar.

## Finitura Lux

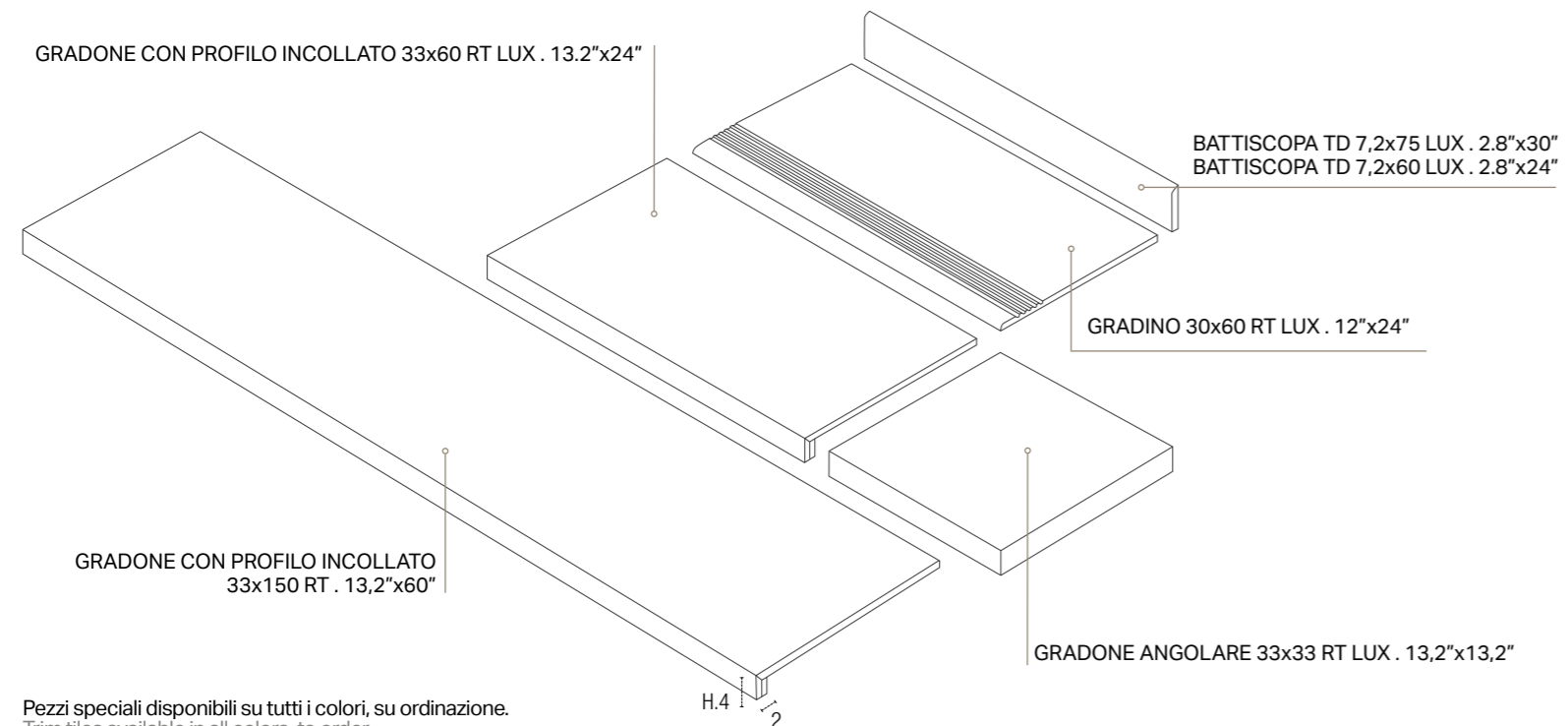

Pezzi speciali disponibili su tutti i colori, su ordinazione.  
Trim tiles available in all colors, to order.  
Pièces spéciales disponibles dans toutes les couleurs, sur demande.  
Formteile auf Bestellung in allen Farben verfügbar.

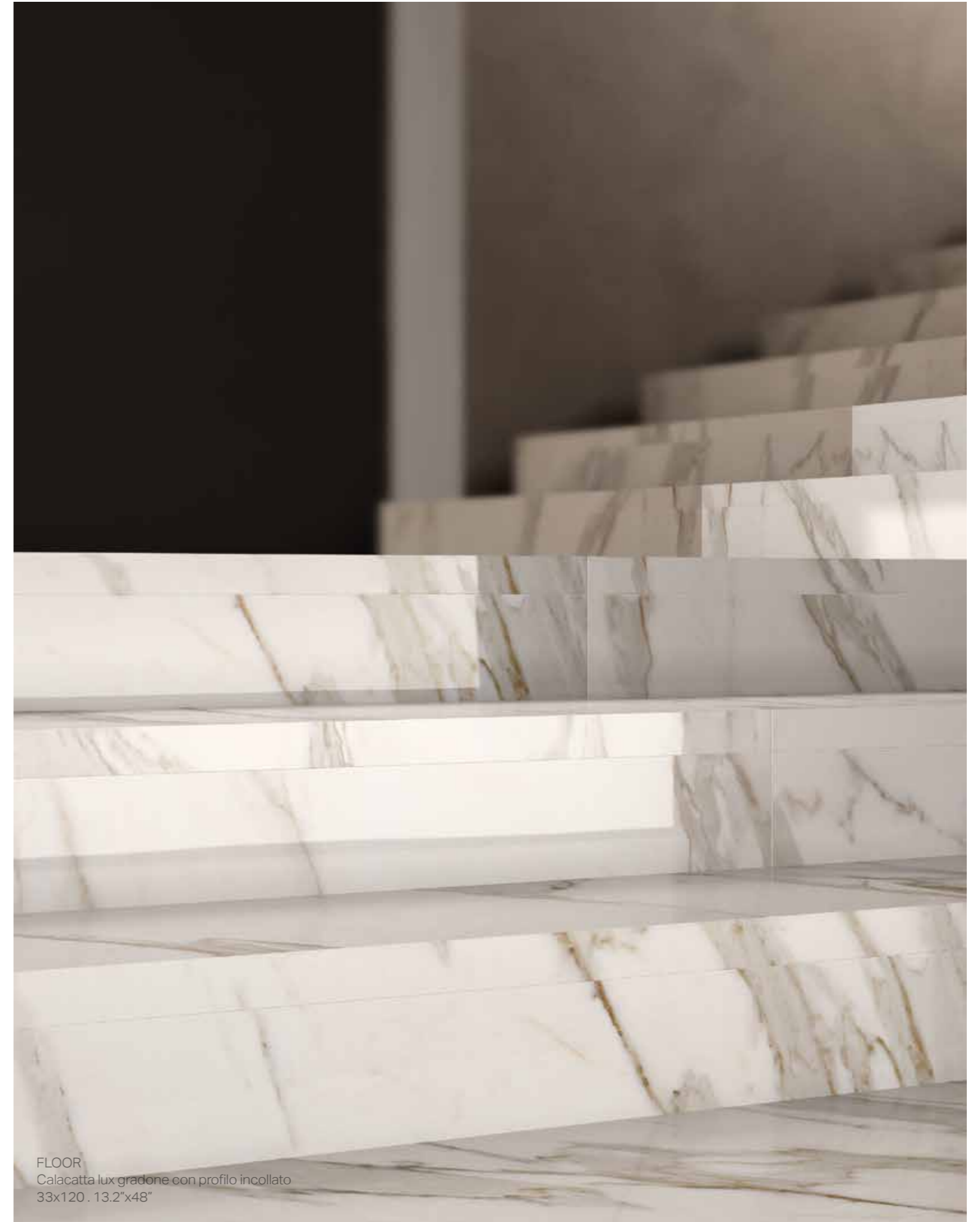

# Imballi

Packing  
Emballage  
Verpackung

GRES PORCELLANATO . Porcelain tiles



\* 120x278 fornito in casse di dimensioni 291,6x144,5x33,8 (PxLxH) cm - Peso kg 88 / o in casse per max 5 pz dim.291.6x144.5x24h - peso kg 52.5  
\* 120x278 supplied in crates. Dimensions crate cm 291,6x144,5x33,8h cm - Weight kg 88 / crates 5 pcs (charge max). Dim.291.6x144.5x24h - Weight kg 52.5

	pz	mq/pz	kg/pz	pz/cassa*	mq/cassa*	kg/cassa*	spessore
120x278 RT LUX / SILK	1	3,336	49,50	18	60,05	979	6 mm
120x278 RT LUX / SILK	1	3,336	49,50	5	16,68	301	6 mm



\*\* 120 x 278 fornito su cavalletti (18 pz o 42 pz - carico max) di dimensioni 290x75x156 (PxLxH) cm - Peso kg 160  
\*\* 120x278 supplied in stand containing (18 pz or 42 pz - charge max). Dimensions cm 290x75x156h cm - Weight kg 160

	pz	mq/pz	kg/pz	pz/cavalletto**	mq/cavalletto**	kg/cavalletto**	spessore
120x278 RT LUX / SILK	1	3,336	49,50	18	60,05	1051	6 mm
120x278 RT LUX / SILK	1	3,336	49,50	42	140,11	2239	6 mm

	pz/box	mq/box	kg/box	box/plt	mq/plt	kg/plt	spessore
120x120 RT LUX / NAT	2	2,88	60,00	20	57,60	1212	9 mm
60x120 RT LUX / NAT	2	1,44	30,00	35	50,40	1062	9 mm
75x150 RT LUX / NAT	2	2,25	46,00	15	33,75	705	9 mm
75x75 RT LUX / NAT	2	1,125	24,00	42	47,25	1020	9 mm
7,2x60 battiscopa	10	6,00 ml	9,00	70	420 ml	645	-
7,2x75 battiscopa	10	7,50 ml	11,00	63	472,50 ml	705	-
33x150 RT gradone c/pr. inc.	2	-	-	-	-	-	-
33x120 RT gradone c/pr. inc.	2	-	-	-	-	-	-
33x75 RT gradone c/profilo incollato	2	-	-	-	-	-	-
33x60 RT gradone c/profilo incollato	4	-	-	-	-	-	-
33x33 RT ang/gradone c/pr.inc.	4	-	-	-	-	-	-
30x60 RT gradino	7	-	-	-	-	-	-

\* disponibile solo su ordinazione / available only upon request

RIVESTIMENTO IN PASTA BIANCA . White body wall tiles

	pz/box	mq/box	kg/box	box/plt	mq/plt	kg/plt	spessore
30,5x91,5 RT	5	1,395	21,00	42	58,59	894	8,5 mm
30,5x91,5 RT struttura FLUID	4	1,12	20,50	42	46,88	873	8,5 mm*
30,5x91,5 RT campitura	2	-	-	-	-	-	-
30,5x30,5 RT brick su rete	6	0,56	7,80	42	23,44	340	-
profilo metallo 0,5x100	3	-	-	-	-	-	8 mm

\* Spessore riferito al fondo liscio equivalente.

Thickness refers to the equivalent smooth background.

Épaisseur se rapportant au carreau lisse équivalent.

Die Stärke bezieht sich auf die entsprechende glatte Grundfliese.

**GRES PORCELLANATO** . Grès cérame . Feinsteinzeug  
Porcelain stoneware

Norma di riferimento: EN 14411 (ISO 13006) Allegato G - Piastrelle di ceramica pressate a secco con basso assorbimento d'acqua (Ev 0,5%)

Norme retenue: EN 14411 (ISO 13006) Annexe G - Carreaux céramiques pressés à sec avec faible absorption d'eau (Ev ≤ 0,5%) . Bezugznorm: EN 14411 (ISO 13006) Anlage G - Trockengepresste keramische Fliesen und Platten mit niedriger Wasseraufnahme (Ev ≤ 0,5%) . Reference standard: EN 14411 (ISO 13006) Appendix G - Dry pressed ceramic tiles with low water absorption (Ev ≤ 0,5%)

**GRUPPO B la**

CARATTERISTICHE TECNICHE . TECHNICAL CHARACTERISTICS Caracteristiquies techniques . Technische eigenschaften	NORMA . NORMS Normes . Normen	REQUISITI RICHIESTI . REQUIREMENTS Conditions requisés . Geforderte eigenschaften			VALORE MEDIO SUPERGRES * Valeur moyenne . Average rating Durchschnittswert			
		7 cm ≤ N < 15 cm	N > 15 cm		SUPERFICIE NATURALE	SUPERFICIE LUX (GL)	SUPERFICIE SILK	
Lunghezza e larghezza dei lati . Lenght and width of the sides Longuer et largeur de côtés . Länge und Breite	ISO 10545-2	RETTIFICATI	± 0,4 mm	± 0,3 %	± 1,0 mm	Conforme . According to Conforme . Gemäss		
Rettilineità degli spigoli . Straightness Equerrage des angles . Kantengeradheit			± 0,4 mm	± 0,3 %	± 0,8 mm	Conforme . According to Conforme . Gemäss		
Ortogonalità** . Rectangularity** Orthogonalité . Rechtwinkligkeit			± 0,4 mm	± 0,3 %	± 1,5 mm	Conforme . According to Conforme . Gemäss		
Planarità . Flatness Planéité . Planität			± 0,6 mm	± 0,4 %	± 1,8 mm	Conforme . According to Conforme . Gemäss		
Spessore . Thickness Epaisseur . Stärke	ISO 10545-2		± 0,5 mm	± 5 %	± 0,5 mm	Conforme . According to Conforme . Gemäss		
Assorbimento % d'acqua . Water absorption Absorption d'eau . Wasseraufnahme	ISO 10545-3		Ev ≤ 0,5%			Conforme . According to Conforme . Gemäss		
Determinazione della resistenza a flessione e della forza di rottura Flexion and break resistance Résistance à la flexion et à la force de rupture Biegefestigkeit und Bruchlast	ISO 10545-4		Spessore ≥ 7,5 mm	S ≥ 1300 R ≥ 35 N/mm <sup>2</sup>	-	Conforme . According to Conforme . Gemäss		
		Spessore < 7,5 mm	S ≥ 700 N R ≥ 35 N/mm <sup>2</sup>					
Determinazione della resistenza all'abrasione Deep Scratch Resistance Résistance à l'abrasion Tiefenverschleissbeständigkeit	ISO 10545-6		≤ 175 mm3			Conforme According to Conforme . Gemäss	-	Conforme According to Conforme . Gemäss
Determinazione della resistenza all'abrasione superficiale PEI Surface abrasion resistance PEI Résistance à l'abrasion superficielle PEI Beständigkeit gegen Abrieb PEI	ISO 10545-7		Classificazione PEI . Classification PEI Classification PEI . Klassifizierung PEI			-	Risultati delle prove disponibili in azienda Test details can be obtained from the company	-
Coefficiente di espansione termica lineare tra 20° e 100° C Linear thermal expansion 20°C to 100°C Dilatation thermique linéaire entre 20°C et 100°C Lineare Waerme-ausdehnung zwischen 20°C und 100°C	ISO 10545-8		Metodo di prova disponibile . Test method available Méthode d'essai disponible . Prüfverfahren verfügbar			Conforme . According to Conforme . Gemäss		
Resistenza agli sbalzi termici . Thermal shock resistance Résistance aux écarts de Température . Temperaturwechselbestaendigkeit	ISO 10545-9		Metodo di prova disponibile . Test method available Méthode d'essai disponible . Prüfverfahren verfügbar			Conforme . According to Conforme . Gemäss		
Resistenza al gelo . Frost resistance Résistance au gel . Frostbeständigkeit	ISO 10545-12		Metodo di prova disponibile . Test method available Méthode d'essai disponible . Prüfverfahren verfügbar			Conforme . According to Conforme . Gemäss		
Reazione al fuoco . Reaction to fire Réaction au feu . Brendverhalten	-		Classe A1 oppure A1 <sub>fl</sub> - Class A1 or A1 <sub>fl</sub> Klasse A1 oder A1 <sub>fl</sub> - Catégorie A1 ou A1 <sub>fl</sub> - Klasse A1 o A1 <sub>fl</sub>			A1-A1 <sub>fl</sub>		
Determinazione della resistenza chimica . Chemical resistance Résistance chimique . Chemikalienbeständigkeit	ISO 10545-13		Classe B minimo . Class B min Catégorie B min . Klasse B min			<b>A LA HA</b>	<b>A LA -</b>	<b>A LA HA</b>
Determinazione della resistenza alle macchie . Resistance to staining Résistance aux taches . Beständigkeit gegen Fleckenbil	ISO 10545-14		Classe 3 minimo . Class 3 min Catégorie 3 min . Klasse 3 min			Conforme . According to Conforme . Gemäss		
Resistenza allo scivolamento . Slip resistance Résistance au glissement . Bestimmung der Rutschemmungsfähigkeit	EN 16165 (Previously DIN 51130)		Classificazione R . Classification R Classification R . Klassifizierung R			<b>R9</b>	-	-
Coefficiente di attrito dinamico Resistance de frottement dynamique Dynamischer reibungskoeffizient Dynamic friction coefficient	METODO B.C.R.A		D.M.I. Giugno 1989 n.236 (μ > 0,40)			Conforme According to Conforme . Gemäss	-	-
Resistenza allo scivolamento - coefficiente di attrito dinamico ( DCOF ) Slip resistance - dynamic friction coefficient Résistance au glissement - resistance de frottement dynamique Bestimmung der Rutschemmungsfähigkeit - dynamischer reibungskoeffizient	ANSI A 326.3		≥ 0,42 wet			Conforme According to Conforme . Gemäss	-	-
					Capraia - Calacatta - Statuario - Lasa - Marfil - Pure White Onyx Pearl - Royal Beige - Supreme Dark - Elegant Greige Eden - Arabescato - Crystal - Invisible Blue			
					<b>V2</b>			
					Paradiso - Breccia Nera - Orobica Grigia Mysterious White - Patagonia Green Calacatta			
					<b>V3</b>			

GRADO DI VARIAZIONE CROMATICA Ogni prodotto si caratterizza per un grado di stonalizzazione variabile da prodotto a prodotto, da colore a colore.

Per stonalizzazione s'intende variazione di gradazione cromatica da piastrella a piastrella. DEGRÉ DE VARIATION CHROMATIQUE Chaque produit est caractérisé par un degré de nuance variable d'un produit à l'autre et d'une couleur à une autre. Par nuance, il faut entendre une variation de la gradation de couleur entre un carreau et un autre, GRAD DER FARBABWEICHUNG Jedes Produkt kennzeichnet sich durch einen bestimmten Grad an Marmorierung (Schattierung), der sich von Produkt zu Produkt, von Farbe zu Farbe unterscheiden kann. Unter Marmorierung versteht man den Grad der Farbänderung von Fliese zu Fliese. COLOUR SHADE VARIATION Every product is characterised by colour-shading that can vary from one product to another and from one colour to another. When referring to colour-shading we refer to the chromatic variation of the tile surface.

**RIVESTIMENTO IN PASTA BIANCA** . Revêtements en pâte blanche - weißscherbiger wandfliesen  
White body wall tiles

Norma di riferimento: EN 14411 (ISO 13006) Allegato L Piastrelle di ceramica pressate a secco (Ev > 10 %)

Reference standard: EN 14411 (ISO 13006) Appendix L Dry pressed ceramic tiles (Ev > 10 %) . Norme retenue: EN 14411 (ISO 13006) Annexe L Carreaux céramiques pressés à sec (Ev > 10 %) . Bezugznorm: EN 14411 (ISO 13006) Anlage L Trockengepresste keramische Fliesen und Platten (Ev > 10 %)

**GRUPPO Billa GL**

CARATTERISTICHE TECNICHE . TECHNICAL CHARACTERISTICS Caracteristiquies techniques . Technische eigenschaften	NORMA . NORMS Normes . Normen	REQUISITI RICHIESTI . REQUIREMENTS Conditions requisés . Geforderte eigenschaften			VALORE MEDIO SUPERGRES * Valeur moyenne . Average rating Durchschnittswert		
Lunghezza e larghezza dei lati . Lenght and width of the sides Longuer et largeur de côtés . Länge und Breite	ISO 10545-2	RETTIFICATI	7 cm ≤ N < 15 cm	N > 15 cm		Conforme . According to Conforme . Gemäss Conforme . Соответствует	
Rettilineità degli spigoli . Straightness Equerrage des angles . Kantengeradheit			± 0,4 mm	± 0,3 %	± 1,0 mm		
Ortogonalità** . Rectangularity** Orthogonalité . Rechtwinkligkeit			± 0,4 mm	± 0,3 %	± 0,8 mm		
Planarità . Flatness Planéité . Planität			± 0,4 mm	± 0,3 %	± 1,5 mm		
Spessore . Thickness Epaisseur . Stärke			± 0,6 mm	± 0,4 %	± 1,8 mm		
Assorbimento % d'acqua . Water absorption Absorption d'eau . Wasseraufnahme	ISO 10545-3		Ev > 10%			Conforme . According to Conforme . Gemäss	
Determinazione della resistenza a flessione e della forza di rottura Flexion and break resistance Résistance à la flexion et à la force de rupture Biegefestigkeit und Bruchlast	ISO 10545-4		Spessore ≥ 7,5 mm	S ≥ 600 N R ≥ 15 N/mm <sup>2</sup>	Conforme . According to Conforme . Gemäss		
Determinazione della resistenza al cavillo Crazing resistance Résistance aux craquelures Haariß-Beständigkeit	ISO 10545-11		Richiesta . Required Requisie . Entforderlich			Conforme . According to Conforme . Gemäss	
Reazione al fuoco . Reaction to fire Réaction au feu . Brendverhalten	-		Classe A1 oppure A1 <sub>fl</sub> - Class A1 or A1 <sub>fl</sub> Klasse A1 oder A1 <sub>fl</sub> - Catégorie A1 ou A1 <sub>fl</sub> - Klasse A1 o A1 <sub>fl</sub>			A1	
Determinazione della resistenza chimica . Chemical resistance Résistance chimique . Chemikalienbeständigkeit	ISO 10545-13		Classe GB minimo . Class GB min Catégorie GB min . Klasse GB min			Conforme . According to Conforme . Gemäss	
Determinazione della resistenza alle macchie . Resistance to staining Résistance aux taches . Beständigkeit gegen Fleckenbil	ISO 10545-14		Classe 3 minimo . Class 3 min Classe 3 min . Catégorie 3 min			Conforme . According to Conforme . Gemäss	

\* Valori riferiti ai fondi. Le caratteristiche tecniche fanno riferimento al formato nominale delle piastrelle espresso in mm.

These values refer to the bottoms. The technical characteristics refer to the nominal size of tiles expressed in mm.  
Valeurs se référant aux fonds. Les caractéristiques techniques se réfèrent au format nominal des carreaux exprimé en mm.  
Werte bezogen auf Grundliesen. Die Angaben beziehen sich auf die Nenngroße der Fliesen in mm.

Se non indicato diversamente, i valori delle prove tecniche si riferiscono alla superficie naturale.

Unless otherwise indicated, the values of technical tests refer to the natural surface finish.  
Sauf indication contraire, les valeurs des tests techniques se rapportent à la surface naturelle.  
Wenn nicht anders angegeben beziehen sich die Werte der technischen Tests auf die natürliche Oberfläche.

\*\* Per piastrelle rettangolari che abbiano il lato maggiore L ≥ 60 cm, e rapporto tra i lati ≥ 3, la misurazione dell'ortogonalità deve venire condotta solo sul lato corto.

For rectangular tiles with longest side L ≥ 60 cm and a ratio length/width L/W ≥ 3, the measurement of orthogonality should only be carried out on short edges.  
Pour les carreaux rectangulaires qui ont le côté le plus long L ≥ 60 cm, et le rapport entre les côtés ≥ 3, la mesure de l'orthogonalité se fait seulement sur le côté le plus court.  
Bei rechteckigen Fliesen, mit der längsten Seite L ≥ 60 cm und einem Seitenverhältnis von ≥ 3 darf die Messung der Rechteckigkeit nur an der kurzen Seite durchgeführt werden.



DISCOVER MORE:



## CERAMICHE SUPERGRES

I dati e le informazioni riportate nel presente catalogo sono aggiornate al momento della stampa e potrebbero subire successive correzioni e/o modifiche. Verificare sempre l'ultima edizione disponibile confrontando la data riportata nell'ultima pagina della versione cartacea, con quella indicata nel pdf del catalogo scaricabile dal sito [www.supergres.com](http://www.supergres.com)

I colori e le caratteristiche estetiche dei prodotti sono indicativi e si avvicinano quanto più possibile a quelli reali nei limiti consentiti dai processi di stampa.

Data and information reported in this catalogue are updated at the moment of catalogue printing therefore they may be subject to subsequent corrections and/or amendments. Always check the latest available issue and compare the date reported on the last page of the hard-paper copy of the catalogue with that stated in the pdf. format downloadable on website [www.supergres.com](http://www.supergres.com)

The colours and aesthetic features of products are indicative and reproduce, as close as possible, the real colours and features taking into consideration the restrictions of printing processes.

© Copyright 2016 Ceramiche Supergres Casalgrande (Reggio Emilia) - Italy  
Pubblicato da Ceramiche Supergres. Strada Statale 467, n° 34 - 42013 Casalgrande (RE) Italy  
Settembre 2016  
Progetto, direzione e coordinamento a cura dell'ufficio marketing Ceramiche Supergres

© Copyright 2016 by Ceramiche Supergres Casalgrande (Reggio Emilia) - Italy  
Published by Ceramiche Supergres. Strada Statale 467, n° 34 - 42013 Casalgrande (RE) Italy  
September 2016  
Project, management and co-ordination by marketing Ceramiche Supergres

Finito di stampare nel mese di Settembre 2024 per conto di Ceramiche Supergres  
Strada Statale 467, n° 34 - 42013 Casalgrande (RE) Italy.

I prodotti, i marchi e le immagini riprodotte nel presente catalogo sono tutelati ai sensi della normativa vigente in materia di proprietà intellettuale. Ogni violazione degli stessi verrà perseguita a norma di legge.

Printed in the month of September 2024 on behalf of Ceramiche Supergres  
Strada Statale 467, n° 34 - 42013 Casalgrande (RE) Italy

All products, trade-marks and photographs reproduced in this catalogue are subject to all existing intellectual property laws. Any breach thereof will be dealt with under the provisions provided by such law.

Office: Strada Statale 467, 34  
42013 Casalgrande (RE) Italy  
Ph. +39 0522 997411  
Fax Export +39 0522 997415  
Fax Italia +39 0522 997494

Warehouse  
Via dell'industria, 1 Villaggio Macina  
42013 Salvaterra di Casalgrande (RE) Italy

[info@supergres.com](mailto:info@supergres.com)  
[www.supergres.com](http://www.supergres.com)

CERAMICHE  
**SUPERGRES**