

Distribuitor în România – Gada Ceramic București, Str. Vlad Județu 48
Website: www.gadaceramic.ro

IRONY

CONTEMPORARY ATTITUDE



CERAMICHE
SUPERGRES

Our idea

CON IRONY VOGLIAMO ESPRIMERE IN UNA SUPERFICIE MODERNA E VERSATILE, UN ATTEGGIAMENTO NON CONVENZIONALE, CHE GUARDA AGLI SPAZI DA ARREDARE CON INTELLIGENZA, SENSO ESTETICO E AUDACE IRONIA.

UNA COLLEZIONE IN GRES PORCELLANATO EFFETTO METALLO CHE INCONTRA LE ESIGENZE DI CHI NE RICERCA IL CARATTERISTICO ASPETTO MODERNO E INDUSTRIALE, ORA ATTUALIZZATO E INGENTILITO DAI DIVERSI ABBINAMENTI SUGGERITI DALLE TENDENZE DEL DESIGN.

Our idea

WITH "IRONY COLLECTION" WE AIM TO CREATE A MODERN, VERSATILE SURFACE WITH AN UNCONVENTIONAL ATTITUDE THAT EXPLORES INTERIOR DESIGN PROJECTS WITH INTELLIGENCE, AESTHETIC SENSE AND A DARING IRONY. A METAL LOOK PORCELAIN TILE COLLECTION DESIGNED TO MEET THE NEEDS OF WHOEVER IS LOOKING THIS MODERN AND DISTINCTIVE MATERIAL, WITH A TOUCH OF INDUSTRIAL CHIC LOOK.

Our idea

AVEC IRONY, NOUS VOULONS EXPRIMER DANS UNE SURFACE MODERNE ET MULTIFONCTIONNELLE UNE ATTITUDE NON CONVENTIONNELLE, QUI PORTE SUR LES ESPACES À AMÉNAGER LE REGARD DE L'INTELLIGENCE, DU SENS ESTHÉTIQUE ET DE L'IRONIE AUDACIEUSE. CETTE COLLECTION EN GRÈS CÉRAMÉ EFFET MÉTAL RÉPOND AUX BESOINS DE CEUX QUI RECHERCHENT SON ASPECT MODERNE ET INDUSTRIEL SI CARACTÉRISTIQUE, AUJOURD'HUI ACTUALISÉ ET POLI PAR DIFFÉRENTES ASSOCIATIONS QUE SUGGÈRENT LES TENDANCES DU DESIGN.

Our idea

MIT IRONY MÖCHTEN WIR IN EINER MODERNEN, VIELSEITIGEN OBERFLÄCHE EINE UNKONVENTIONELLE HALTUNG ZUM AUSDRUCK BRINGEN, MIT EINEM INTELLIGENTEN BLICK MIT SINN FÜR ÄSTHETIK UND KÜHNER IRONIE FÜR RÄUME. ES HANDELT SICH UM EINE KOLLEKTION AUS FEINSTEINZEUG IN METALLOPTIK, DIE DIE BEDÜRFNISSE ALL JENER ERFÜLLT, DIE DEN TYPISCHEN MODERNEN INDUSTRIAL LOOK SUCHE. DIESER PRÄSENTIERT SICH HIER IN ZEITGEMÄSSEN, DURCH VERSCHIEDENE VON DEN DESIGNTRENDS INSPIRIERTEN, ABGEMILDERTEN KOMBINATIONEN.



Modern Look

IL DESIGN CONTEMPORANEO DEL METALLO
CONFERISCE UN ASPETTO MODERNO
AD OGNI AMBIENTE.

IL SUO FORTE ASPETTO ESPRESSIVO,
LA VERSATILITÀ E MATERICITÀ, LO RENDONO
ADATTO ALLE RICERCHE DI LOOK DI TENDENZA,
CHE SEMPRE PIÙ GUARDANO ALLA FUSIONE
DI STILI ARCHITETTONICI.

Modern Look

THE CONTEMPORARY DESIGN PERSONALITY OF METAL
GIVES A FRESH TOUCH TO EVERY INTERIORS EITHER RESIDENTIAL
OR A COMMERCIAL.

ITS STRONGLY EXPRESSIVE APPEARANCE, VERSATILITY,
AND TACTILE ALLURE MAKE IT IDEAL FOR THE CREATION OF
TRENDY LOOKS, WHICH INCREASINGLY INVOLVE A FUSION OF
ARCHITECTURAL STYLES.

Modern Look

LE DESIGN CONTEMPORAIN DU MÉTAL DONNE UN ASPECT
MODERNE À CHAQUE ESPACE.

SA FORTE EXPRESSIVITÉ, SA POLYVALENCE ET SA MATÉRIALITÉ LUI
PERMETTENT DE S'ADAPTER AUX RECHERCHES DE LOOKS ET DE
TENDANCES, QUI S'INSCRIVENT TOUJOURS PLUS DANS
LA FUSION DES STYLES ARCHITECTURAUX.

Modern Look

DAS ZEITGEMÄSSE DESIGN DES METALLS VERLEIHT JEDEM RAUM
EINEN MODERNEN TOUCH. DURCH SEINE AUSDRUCKSKRAFT,
VIELSEITIGKEIT UND MATERIALBETONTHEIT EIGNET ES SICH
FÜR ANGESAGTE LOOKS, BEI DENEN VERMEHRT AUF DIE
VERSCHMELZUNG VON ARCHITEKTURSTILEN WERT GELEGT WIRD.

Contemporary Attitude

É POSSIBILE ABBINARE IRONY CON DIVERSI MATERIALI DI PREGIO, E FONDERLO IN UN MIX DI STILI DIFFERENTI; IL SUO CARATTERE AUDACE SPINGE A RICERCARE SOLUZIONI ESTETICHE NUOVE.

Contemporary Attitude

IRONY CAN BE COMBINED WITH A WIDE VARIETY OF MATERIALS IN A MIX OF DIFFERENT STYLES. ITS AUDACIOUS PERSONALITY DRIVES THE SEARCH FOR CONTEMPORARY AESTHETIC SOLUTIONS.

Contemporary Attitude

ON PEUT ASSOCIER IRONY À DIVERS MATÉRIAUX ET LA FONDRER DANS UN MÉLANGE DE STYLES DIFFÉRENTS. SON CARACTÈRE AUDACIEUX Pousse À LA RECHERCHE DE SOLUTIONS ESTHÉTIQUES NOUVELLES.

Contemporary Attitude

IRONY KANN MIT VERSCHIEDENEN MATERIALIEN KOMBINIERT UND IN EINEN MIX AUS UNTERSCHIEDLICHEN STILEN EINBEZOGEN WERDEN. SEINE KÜHNE ANMUTUNG IST EINE EINLADUNG ZUR SUCHE NACH NEUEN ÄSTHETISCHEN LÖSUNGEN.



IRONY Uses



UNCONVENTIONAL
COMMERCIAL

SOFISTICATED WALL



BOLD
RESIDENTIAL



RESOLUTE FLOOR



6 Colors

5 Sizes



TIN



OXIDE



SILVER



CORTEN



ZINC



LEAD

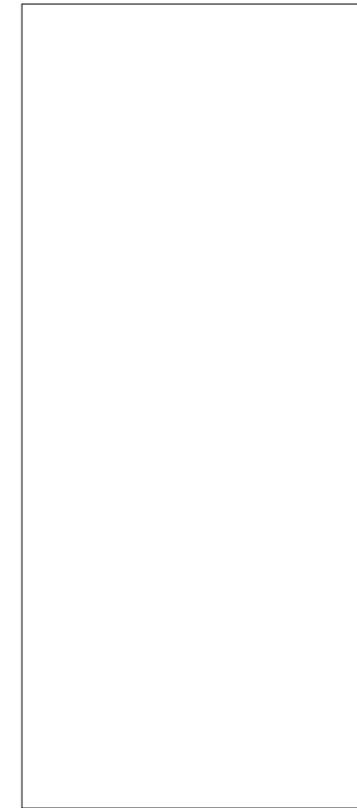

120×278 RT | 48"×109^{1/2}"
±6mm

- LEAD
- OXIDE
- CORTEN

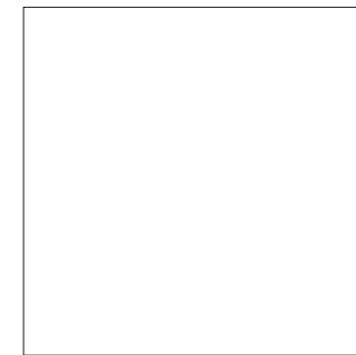

120×120 RT | 48"×48"
±9mm | R10 B

- LEAD
- OXIDE
- CORTEN
- ZINC
- SILVER
- TIN

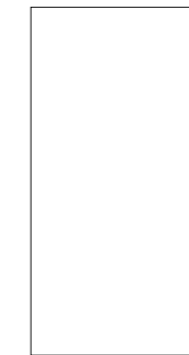

60×120 RT | 24"×48"
±9mm | R10 B

- LEAD
- OXIDE
- CORTEN
- ZINC
- SILVER
- TIN

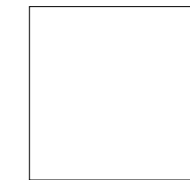

60×60 RT | 24"×24"
±9mm | R10 B

- LEAD
- ZINC
- SILVER
- TIN



30×60 RT | 12"×24"
±9mm | R10 B

- LEAD
- ZINC
- SILVER
- TIN

Silver

L'AMORE È COME L'ARGENTO
VIVO NELLE TUE MANI.

Dorothy Parker

LOVE IS LIKE QUICKSILVER
IN YOUR HANDS.

L'AMOUR EST COMME DU VIF-ARGENT
QUI COULE ENTRE LES MAINS.

LIEBE IST WIE QUECKSILBER,
DAS MAN IN DER HAND HAT.

Silver 120x120RT 48"x48"
Corten 120x278RT 48"x109 1\2"

IRONY
Silver | Corten

Distribuitor în România – Gada Ceramic București, Str. Vlad Județu 48
Website: www.gadaceramic.ro

CERAMICHE
SUPERGRES



Silver 120x120RT 48"x48"
Corten 120x278RT 48"x109 1/2"

Lead

I METALLI SI RICONOSCONO
DAL SUONO, LE PERSONE DALLE PAROLE
E, SOPRATTUTTO, DALLE AZIONI.

Baltasar Gracián

YOU TELL A METAL BY ITS SOUND BUT YOU TELL PEOPLE
BY THEIR WORDS AND ABOVE ALL THEIR ACTIONS.

LES MÉTAUX SE RECONNAISSENT À LEUR SON, LES PERSONNES
À LEURS MOTS ET, SURTOUT, À LEURS ACTIONS.

AM KLANGE ERKENNT MAN DAS METALL, AN DER REDE UND
VOR ALLEM AN DEN TATEN DEN MENSCHEN.



Lead 120x120RT 48"x48"
4havana T20 30x120RT 12"x48"



Lead 120x120RT 48"x48"
4havana T20 30x120RT 12"x48"

IRONY

Lead | Shade Corten

Distribuitor în România - Gada Ceramic București, Str. Vlad Județu 48
Website: www.gadaceramic.ro



Lead 120x120RT 48"x48"
Irony C.Shade Corten 120x278RT 48"x109 1\2"

IRONY

Lead | Shade Corten



Lead 120x120RT 48"x48"



Lead 120x120RT 48"x48"
Irony C.Shade Corten 120x278RT 48"x109 1/2"



Corten

IL CORTEN HA UN VALORE ESTETICO CHE NON HO DIFFICOLTÀ A DEFINIRE ASSOLUTO.

Romolo Tancredi

THE CORTEN STEEL HAS AN AESTHETIC VALUE THAT I HAVE NO DIFFICULTY IN DEFINING AS ABSOLUTE.

LE CORTEN A UNE VALEUR ESTHÉTIQUE QUE JE N'AI AUCUNE DIFFICULTÉ À DÉFINIR ABSOLU.

CORTEN BESITZT EINEN UNVERGLEICHLICHEN ÄSTHETISCHEN WERT.

Tin 120x120RT 48"x48"
Corten 120x278RT 48"x109 1/2"

IRONY

Corten | Iin

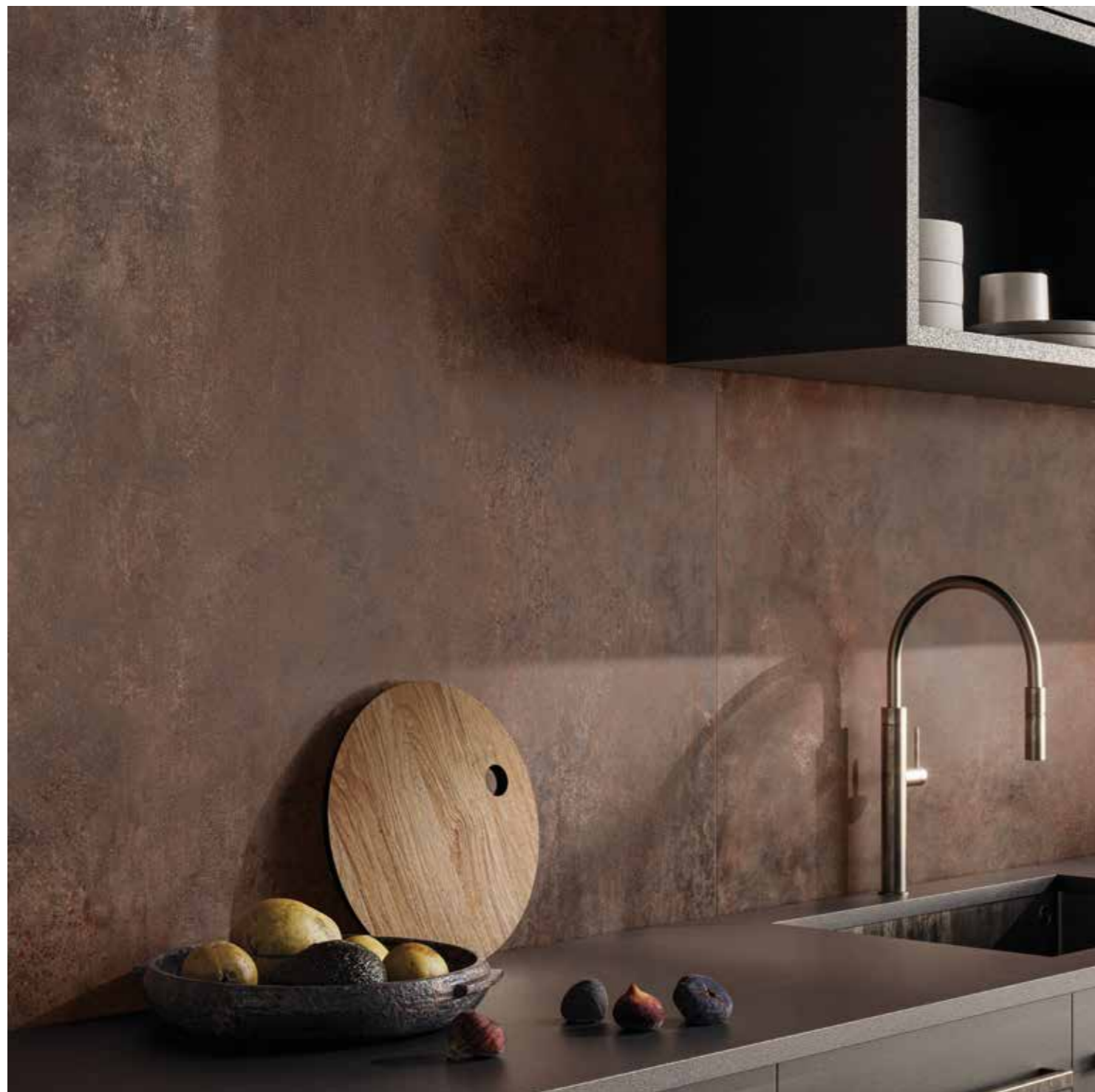

Corten 120x278RT48"x109 1\2"



Iin 120x120RT 48"x48"

Oxide

OGNI METALLO
HA UN DETERMINATO POTERE,
DIVERSO DA METALLO A METALLO.

Alessandro Volta

EVERY METAL HAS A SPECIFIC POWER, WHICH
VARIES FROM METAL TO METAL.

CHAQUE MÉTAL A UN POUVOIR BIEN À LUI,
DIFFÉRENT D'UN MÉTAL À L'AUTRE.

JEDES METALL HAT EINE BESTIMMTE
FÄHIGKEIT, DIE SICH VON METALL ZU METALL
UNTERSCHIEDET.



IRONY

Oxide | Damask



Oxide 120X120RT 48"x48"
Irony Camp. Damask 120x278RT 48"x109 1/2"

Distribuitoar în România – Gada Ceramic București, Str. Vlad Județu 48
Website: www.gadaceramic.ro

Tin

LA RIVOLUZIONE DEL
METALLO È LA PIÙ GRANDE
CHE IL MONDO ABBIA MAI
VEDUTO, E CHE MAI POTRÀ
VEDERE.

Edward Clodd

THE REVOLUTION OF METALS IS THE
GREATEST THAT THE WORLD HAS EVER SEEN,
AND WILL NEVER SEE AGAIN.

LA RÉVOLUTION DES MÉTAUX EST LA PLUS
GRANDE QUE LE MONDE AIT JAMAIS VUE, ET
QU'IL NE VERRA JAMAIS.

DIE METALLREVOLUTION IST DIE GRÖSSTE,
DIE DIE WELT JE GESEHEN HAT UND JEMALS
SEHEN WIRD

Tin 120x120RT 48"x48"
Oxide 120x120RT 48"x48"
Oxide 120x278RT 48"x109 1\2"

IRONY

Tin | Oxide



Tin 120x120RT 48"x48"
Oxide 120x120RT 48"x48"
Oxide 120x278RT 48"x109 1\2"

Zinc

SCRIVO QUESTE PAROLE
NELL'ACCIAIO, POICHÉ NULLA
CHE NON SIA SCRITTO NEL
METALLO PUÒ ESSERE
AFFIDABILE.

Brandon Sanderson

I'M WRITING THESE WORDS IN
STEEL, BECAUSE YOU CAN'T TRUST
ANYTHING NOT WRITTEN IN METAL.

J'ÉCRIS CES MOTS DANS L'ACIER, CAR
RIEN DE CE QUI N'EST GRAVÉ DANS LE
MÉTAL N'EST DIGNE DE CONFIANCE.

ICH SCHREIBE DIESE WORTE IN
STAHL, DENN MAN KANN NICHTS
TRAUEN, DAS NICHT IN METALL
BEWAHRT IST.



Zinc 120x120RT 48"x48"

IRONY
Zinc | Lead

Distribuitor în România – Gada Ceramic București, Str. Vlad Județu 48
Website: www.gadaceramic.ro

CERAMICHE
SUPERGRES



Zinc 120x120RT 48"x48"
Lead 120x278RT 48"x109 1/2"

Tin

R10 B | 120x120RT | 60x120RT | 60x60RT | 30x60RT



120x120 RT | 48"x48"
✂ 9mm | R10 B

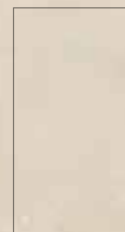

60x120 RT | 24"x48"
✂ 9mm | R10 B



60x60 RT | 24"x24"
✂ 9mm | R10 B



30x60 RT | 12"x24"
✂ 9mm | R10 B

Oxide

NATURALE | 120x278 RT
R10 B | 120x120RT | 60x120RT



120x278 RT | 48"x109 1/2"
✂ 6mm



120x120 RT | 48"x48"
✂ 9mm | R10 B



60x120 RT | 24"x48"
✂ 9mm | R10 B

Silver

R10 B | 120x120RT | 60x120RT | 60x60RT | 30x60RT



120x120 RT | 48"x48"
✂ 9mm | R10 B

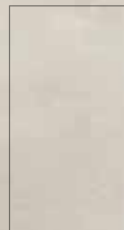

60x120 RT | 24"x48"
✂ 9mm | R10 B



60x60 RT | 24"x24"
✂ 9mm | R10 B

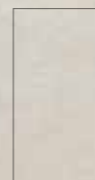

30x60 RT | 12"x24"
✂ 9mm | R10 B

Corten

NATURALE | 120x278 RT
R10 B | 120x120RT | 60x120RT



120x278 RT | 48"x109 1/2"
✂ 6mm



120x120 RT | 48"x48"
✂ 9mm | R10 B



60x120 RT | 24"x48"
✂ 9mm | R10 B

Zinc

R10 B | 120x120RT | 60x120RT | 60x60RT | 30x60RT



120x120 RT | 48"x48"
✂️ 9mm | R10 B



60x120 RT | 24"x48"
✂️ 9mm | R10 B



60x60 RT | 24"x24"
✂️ 9mm | R10 B



30x60 RT | 12"x24"
✂️ 9mm | R10 B

Lead

NATURALE | 120x278 RT

R10 B | 120x120RT | 60x120RT | 60x60RT | 30x60RT



120x278 RT | 48"x109 1/2"
✂️ 6mm



120x120 RT | 48"x48"
✂️ 9mm | R10 B



60x120 RT | 24"x48"
✂️ 9mm | R10 B

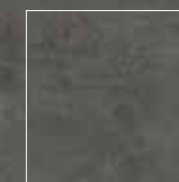

60x60 RT | 24"x24"
✂️ 9mm | R10 B



30x60 RT | 12"x24"
✂️ 9mm | R10 B

DECORS



A



B

Camp. Shade Corten 2/S
120×278 RT | 48"×109 1/2"
⊗ 6mm



A



B

Camp. Shade Oxide 2/S
120×278 RT | 48"×109 1/2"
⊗ 6mm



Camp. Damask
120×278 RT | 48"×109 1/2"
⊗ 6mm



Irony c.Damask 120x287RT 48"×109 1/2"

Disponibili solo su ordinazione / Available only upon request



MOSAICO

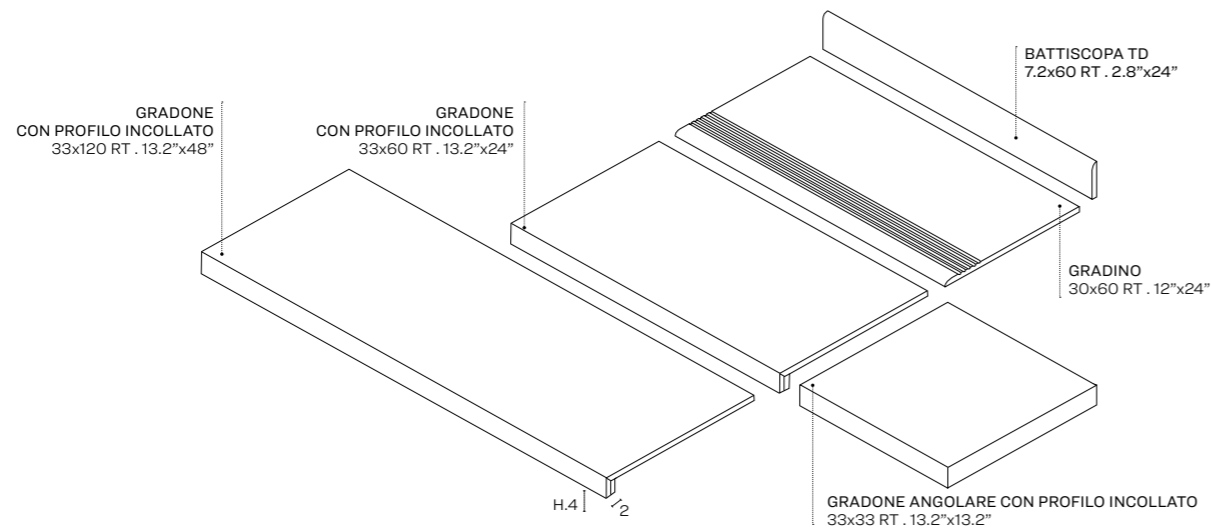

PEZZI SPECIALI | SPECIAL TILES | PIÈCES SPÉCIALES | FORMTEILE



IMBALLI | EMBALLAGE | VERPACKUNG | PACKING

| | pz/box | mq/box | kg/box | box/plt | mq/plt | kg/plt | spessore |
|---|--------|---------|--------|---------|--------|--------|----------|
| 120x278RT cassa / crate cm 291,6x144,5x33,8 kg 88 | 1 | 3,336 | 49,50 | 18 | 60,05 | 979 | 6 mm |
|  * 120x278 fornito in casse di dimensioni 291,6x144,5x33,8 (PxLxH) cm - Peso kg 88 / o in casse per max 5 pz dim.291,6x144,5x24h - peso kg 52,5 * 120x278 supplied in crates. Dimensions crate cm 291,6x144,5x33,8h cm - Weight kg 88 / crates 5 pcs (charge max). Dim.291,6x144,5x24h - Weight kg 52,5 | | | | | | | |
| 120x278RT cassa leggera (max 5pz) cm 291,6x144,5x24 kg 54 | 1 | 3,336 | 49,50 | 5 | 16,68 | 301 | 6 mm |
| 120x278RT cavalletto / stand containing (18pz) (carico max / charge max 42pz) | 1 | 3,336 | 49,50 | 18 | 60,05 | 1051 | 6 mm |
|  ** 120x278 fornito su cavalletti (18 pz o 42 pz - carico max) di dimensioni 290x75x156 (PxLxH) cm - Peso kg 160 ** 120x278 supplied in stand containing (18 pcs or 42 pcs - charge max). Dimensions cm 290x75x156h cm - Weight kg 160 | | | | | | | |
| | pz/box | mq/box | kg/box | box/plt | mq/plt | kg/plt | spessore |
| 120x120RT | 2 | 2,88 | 60,00 | 20 | 57,60 | 1212 | 9 mm |
| 60x120RT | 2 | 1,44 | 30,00 | 35 | 50,40 | 1062 | 9 mm |
| 60x60RT | 3 | 1,08 | 22,00 | 40 | 43,20 | 892 | 9 mm |
| 30x60 RT | 7 | 1,26 | 25,00 | 40 | 50,40 | 1012 | 9 mm |
| mosaico 30x30RT | 10 | 0,90 | 16,00 | 30 | 27,00 | 495 | 9 mm |
| battiscopa 7,2x60 | 10 | 6,00 ml | 9,00 | 70 | 420 ml | 645 | - |
| gradone c/p inc. 33x120RT | 2 | - | - | - | - | - | - |
| gradone c/p inc. 33x60RT | 4 | - | - | - | - | - | - |
| angolare gradone c/p inc. 33x33RT | 4 | - | - | - | - | - | - |
| gradino 30x60RT | 7 | - | - | - | - | - | - |

AVVERTENZE PER LA POSA | RECOMMENDATIONS FOR INSTALLATION
RECOMMANDATIONS POUR LA POSE | VERLEGETIPPS

Per la posa del materiale rettificato si prescrive una fuga minima di 2 mm . As for rectified materials, a minimum joint of 2 mm is required . Pour la pose du matériau rectifié, il faut réaliser un joint minimum de 2 mm . Für die Verlegung des geschliffenen Materials ist eine Mindestfuge von 2 mm vorgeschrieben .

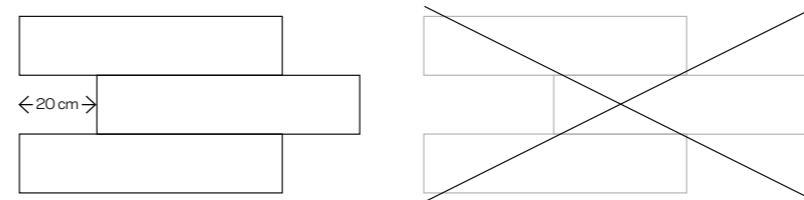

Si raccomanda di posare i materiali sfalsati di 20 cm al massimo, mai a metà della loro lunghezza . It is strongly recommended to install the materials in a staggered pattern of a maximum of 20 cm, never at half way its length . Il est conseillé de poser les matériaux en décalé de 20 cm au maximum, jamais à la moitié de leur longueur . Es wird empfohlen, die Materialien um höchstens 20 cm versetzt zu verlegen und nie in der Mitte ihrer Länge

DISCLAIMER

Supergres raccomanda l'utilizzo a pavimento di lastre in spessore 6 mm per le sole applicazioni in ambito residenziale, commerciale a traffico leggero e comunque in contesti ove non vi sia passaggio di carichi puntuali pesanti o transito di carrelli a ruote dure.

Le lastre a 6mm, grazie al loro spessore ridotto, sono particolarmente indicate per la posa su pavimenti o rivestimenti preesistenti in marmo, pietra naturale, ceramica, senza la necessità di demolire la pavimentazione sottostante. Tale pavimentazione preesistente dovrà però essere planare, stabile, rigida e priva di rotture. In tutti questi casi sarà necessario valutare attentamente, assieme al progettista della pavimentazione, l'idoneità del sottofondo. In caso di dubbio sarà necessario valutare la necessità della demolizione e/o l'utilizzo di spessori tradizionali.

Supergres sconsiglia la posa delle lastre in 6 mm di spessore direttamente su massetto in quanto tale applicazione è fortemente condizionata dall'esecuzione ottimale del massetto stesso, dalla sua completa stagionatura, dal rispetto degli opportuni giunti di dilatazione nonché dalla posa effettuata a "regola d'arte". Pertanto in caso di posa diretta su massetto, Supergres suggerisce l'utilizzo del gres porcellanato a spessore tradizionale.

In generale, per l'applicazione a pavimento delle lastre in spessore 6mm, l'adesivo (da scegliere insieme al progettista in base alle caratteristiche del cantiere) dovrà essere applicato secondo il metodo della doppia spalmatura, al fine di assicurare la perfetta distribuzione dello stesso e di garantire un'adesione ottimale, evitando la formazione di eventuali vuoti che potrebbero essere causa di rotture.

Supergres stresses that slabs 6 mm in thickness may only be used as flooring in residential and commercial environments that are subject to light traffic, and furthermore, in contexts where there is no circulation of heavy loads or hard-tyre trolleys. Thanks to the reduced thickness, the 6 mm slabs are a good solution for laying over pre-existing floors or tiling in marble, natural stone or ceramics, and avoid the necessity of demolishing the underlying floor. Such preexisting flooring must, however, be even, stable, rigid and without breakages. Even if the floor conforms to all the above conditions, it is still necessary, together with the flooring project manager, to evaluate the suitability of the underlying layer. If there are any doubts, the need for demolition and/ or the use of traditional thickness must be evaluated.

Supergres does not recommend the installation of 6 mm thickness on a slab since the results of installation strictly relate to the condition - excellent - of the slab, to its seasoning, to the provision of expansion joints, as well as to perfect installation in accordance to "the rules of the trade". If you are tiling a new slab, Supergres recommends the use of porcelain stoneware with a standard thickness.

In general, when laying a floor of 6 mm thick slabs, the adhesive (to be selected together with the project manager based on the characteristics of the construction) must be applied using the double bonding technique, aimed at ensuring the perfect distribution of the adhesive to guarantee the best bond, avoiding the presence of any hollows that could cause breakages.

Supergres recommande l'utilisation au sol de plaques de 6 mm d'épaisseur uniquement pour des applications dans un contexte résidentiel et commercial à faible affluence ainsi que dans des contextes dépourvus de passages de charges ponctuelles lourdes ou de chariots à roues dures.

Les plaques de 6 mm d'épaisseur, grâce à leur épaisseur réduite, sont particulièrement adaptées à une pose sur des sols ou des revêtements préexistants en marbre, en pierre naturelle et en céramique, sans impliquer la démolition de la sous-couche. Cette sous-couche préexistante devra toutefois être plane, stable, rigide et privée de ruptures. Il sera dans tous les cas nécessaire d'évaluer attentivement, avec le concepteur du sol, la conformité de la sous-couche. En cas de doute, il sera nécessaire d'évaluer la nécessité de la démolition et/ou l'utilisation d'épaisseurs traditionnelles. Supergres déconseille la pose directe de plaques de 6mm d'épaisseur sur une chape car le résultat dépend de la bonne exécution de la chape, de son séchage complet, du respect des joints de dilatation ainsi que de la pose effectuée selon les règles de l'art. Par conséquent, pour une pose directe sur une chape, Supergres préconise un carrelage en grès cérame d'une épaisseur traditionnelle.

En général, pour l'application au sol des plaques de 6 mm d'épaisseur, l'adhésif (à choisir avec le concepteur en fonction des caractéristiques du chantier) devra être appliqué suivant la méthode du double encollage afin de garantir non seulement la répartition parfaite de ce dernier mais aussi une adhérence optimale, en évitant ainsi la formation de vides éventuels qui pourrait provoquer des ruptures.

Supergres empfiehlt die Verwendung von Platten mit Stärke 6 mm als Bodenbelag nur für Anwendungen im Privatbereich und in Gewerbe- und Objektbereichen mit geringer Trittbelastung, oder in Bereichen, in denen zumindest keine Rollwagen mit harten Rädern zum Einsatz kommen oder schwere punktuelle Belastungen auftreten. Die 6 mm starken Platten eignen sich aufgrund ihrer geringen Stärke besonders für die Verlegung auf bestehenden Bodenbelägen oder Wandverkleidungen aus Marmor, Naturstein, Keramik, ohne dass der darunterliegende Belag zuvor entfernt werden muss. Dieser bereits vorhandene Boden muss jedoch eben, stabil, hart und bruchstabil sein. In all diesen Fällen muss die Eignung des Untergrundes gemeinsam mit dem Architekten oder Planer zuvor sorgfältig geprüft werden. Im Zweifelsfall muss die Notwendigkeit einer Entfernung des bestehenden Bodenbelags und/oder die Verwendung herkömmlicher Stärken in Erwägung gezogen werden.

Supergres rät davon ab, 6mm starken Platten direkt auf Estrich zu verlegen, da eine solche Anwendung stark von einer optimalen Anfertigung des Estrichs selbst abhängig ist, sowie von seiner kompletten Belegreife, der Einhaltung der notwendigen Dehnungsfugen, sowie von einer „fachgerechten“ Verlegung. Deshalb empfiehlt Supergres im Falle einer direkten Verlegung auf Estrich, Steinzeug mit traditioneller Dicke zu verwenden.

Im Allgemeinen muss bei der Verlegung von 6 mm starken Platten als Bodenbelag der Klebstoff (der zusammen mit dem Planer nach den Eigenschaften des Verwendungsorts ausgewählt wird) doppelt aufgetragen werden (sowohl auf dem Untergrund als auch auf der Rückseite der Platte), um eine perfekte Verteilung und eine optimale Haftung zu gewährleisten und die Bildung von Hohlräumen zu vermeiden, die zu Bruch führen könnten.

Ceramics. A safe choice.



IGIENICA Hygienic

La ceramica è facile da pulire, igienica e pratica; basta un semplice detergente neutro per rimuovere lo sporco e facilmente ritorna alla sua bellezza originaria.

Ceramic material is easy to clean, hygienic and practical; all it takes is a simple, neutral detergent to remove dirt and restore it to its original splendour.

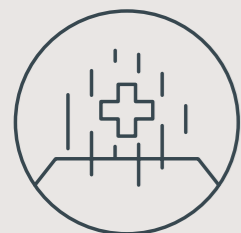

SALUBRE Healthy

Grazie alle sue caratteristiche fisiche la ceramica non rilascia alcuna sostanza nociva o VOC (sostanze organiche volatili) nell'ambiente in cui viviamo. Allo stesso modo non emette odori. Il gres porcellanato è privo di PVC, plastiche o derivati del petrolio.

Thanks to its physical characteristics, ceramic material does not release any harmful substances or VOC (volatile organic substances) into the environment we live in, nor does it give off odours. Porcelain tiles contain no PVC, plastic or petroleum derivatives.



RESISTENTE ALL'USURA Wear resistant

Il gres porcellanato è un materiale tecnico ultra compatto, altamente resistente all'usura; sopporta bene calpestio, urti, graffi e carichi pesanti.

Porcelain stoneware is an ultra-compact technical material, extremely resistant to wear, tread, shock, scratching and heavy loads.

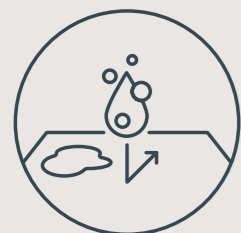

ANTIMACCHIA Stain resistant

La ceramica non teme macchie e non viene danneggiata con l'utilizzo di solventi e detersivi.

Ceramic material is resistant to stains and is not damaged by the use of solvents and detergents.

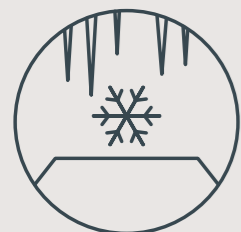

INGELIVA Frostproof

Il gres porcellanato resiste al gelo e a tutti gli attacchi degli agenti atmosferici, ed è quindi il prodotto ideale anche in ambienti esterni.

Porcelain stoneware is resistant to frost and to all kinds of attack from the elements, making it the ideal product also for outdoors.



PRODOTTO NEL RISPETTO DELL'AMBIENTE Eco-sustainable production

Il processo produttivo aziendale impiega un sistema di raccolta e di riutilizzo degli scarti di produzione, delle acque di lavorazione e del calore generato nelle fasi di produzione. In questo modo si limita il consumo di energia e di materie prime, per un'economia più sostenibile e un ridotto impatto ambientale.

The company's production process uses a system that collects and re-uses production waste, processing water and the heat generated during the production process, thus limiting the consumption of energy and raw materials, for a more sustainable economy and lower environmental impact.

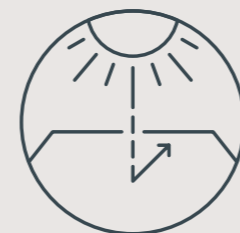

RESISTENTE AI RAGGI UV Resistant to UV rays

Esposta al sole anche per lungo tempo la ceramica non cambia colore, e mantiene inalterate nel tempo le sue caratteristiche estetiche e tecniche.

Ceramic material does not fade even after lengthy exposure to sunlight, and maintains its aesthetic and technical characteristics over time.



PRODOTTO IGNIFUGO Fireproof

Resiste al fuoco e non emette fumi in seguito alla combustione.

Resistant to fire and does not emit smoke upon combustion.



IDEALE PER RISCALDAMENTO A PAVIMENTO Ideal for underfloor heating

Ottime conduttrici di calore, il gres porcellanato si riscalda rapidamente e il calore è rilasciato immediatamente nell'ambiente; in questo modo consente di mantenere limitate temperature d'esercizio dell'impianto di riscaldamento.

An excellent conductor of heat, porcelain stoneware warms up quickly and releases heat into the air immediately, making it possible to keep the heating system working temperatures lower.

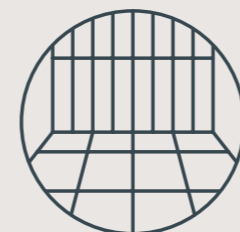

VERSATILE Versatile

La ceramica consente tante variazioni di stile e design, grazie all'ampia disponibilità di formati, spessori, finiture e tinte. Inoltre può essere utilizzata in qualsiasi ambiente, sia a pavimento che a rivestimento, in interno o esterno, in ambienti residenziali o pubblici.

All sorts of style and design variants are possible with ceramics, thanks to the wide availability of different sizes, thicknesses, finishes and colours. It can also be used anywhere, on both floors and walls, indoors or outdoors, in residential or public settings.

Sustainability

RESPONSIBILITY IS WHAT WE DO

Responsabilità è ciò che facciamo ogni giorno. Non solo un dovere, ma un impegno per fare la differenza, creando un ambiente sano e sicuro dove tutti possano vivere, lavorare e realizzarsi. Adottare un nuovo mindset e scegliere l'alternativa più sostenibile è un vero atto di responsabilità.

Un atto di responsabilità globale, perché le sfide che affrontiamo non hanno confini.

Un atto di responsabilità territoriale, perché vogliamo fare la differenza con il nostro lavoro, per le persone, l'ambiente e le comunità che ci circondano.



Responsibility is what we do every day. A commitment to make a difference, creating a healthy and safe environment where everyone can live, work, and thrive. Adopting a new mindset and choosing the most sustainable alternative is a true act of responsibility.

An act of global responsibility, because the challenges we face have no boundaries.

An act of territorial responsibility, because we want to make a difference with our work, for the people, the environment, and the communities that surround us.



| CARATTERISTICHE TECNICHE . TECHNICAL CHARACTERISTICS Caracteristiques techniques . Technische eigenschaften | NORMA NORMS Normes Normen | REQUISITI RICHIESTI . REQUIREMENTS Conditions requisés . Geforderte eigenschaften | | VALORE MEDIO SUPERGRES * Valeur moyenne . Average rating | | |
|---|---------------------------------------|--|--|---|--|--|
| | | N > 15 cm | | SUPERFICIE NATURALE | | |
| Lunghezza e larghezza dei lati . Length and width of the sides Longueur et largeur de côtés . Länge und Breite | ISO 10545-2 | RETTIFICATI | ± 0,3 % | ± 1,0 mm | Conforme . According to Conforme . Gemäss | |
| Rettilinearità degli spigoli . Straightness Equerrage des angles . Kantengeradheit | | | ± 0,3 % | ± 0,8 mm | Conforme . According to Conforme . Gemäss | |
| Ortogonalità** . Rectangularity** Orthogonalité . Rechtwinkligkeit | | | ± 0,3 % | ± 1,5 mm | Conforme . According to Conforme . Gemäss | |
| Planarità . Flatness Planéité . Planität | | | ± 0,6 mm ± 0,4 % | ± 1,8 mm | Conforme . According to Conforme . Gemäss | |
| Spessore . Thickness Epaisseur . Stärke | ISO 10545-2 | | ± 0,5 mm | ± 5 % | ± 0,5 mm | Conforme . According to Conforme . Gemäss |
| Assorbimento % d'acqua . Water absorption Absorption d'eau . Wasseraufnahme | ISO 10545-3 | | Ev ≤ 0,5% | | Conforme . According to Conforme . Gemäss | |
| Determinazione della resistenza a flessione e della forza di rottura Flexion and break resistance Résistance à la flexion et à la force de rupture Biegefestigkeit und Bruchlast | ISO 10545-4 | | Spessore ≥ 7,5 mm | S ≥ 1300 R ≥ 35 N/mm2 | Conforme . According to Conforme . Gemäss | |
| Determinazione della resistenza all'abrasione profonda Deep Scratch Resistance Résistance à l'abrasion profonde Tiefenverschleissbeständigkeit | ISO 10545-6 | | ≤ 175 mm² | | Conforme According to Conforme . Gemäss | |
| Coefficiente di espansione termica lineare tra 20° e 100° C Linear thermal expansion 20°C to 100°C Dilatation thermique linéaire entre 20°C et 100°C Lineare Waerme-ausdehnung zwischen 20°C und 100°C | ISO 10545-8 | | Metodo di prova disponibile . Test method available Méthode d'essai disponible . Prüfverfahren verfügbar | | Conforme . According to Conforme . Gemäss | |
| Resistenza agli sbalzi termici . Thermal shock resistance Résistance aux écarts de Température . Temperaturwechselbeständigkeit | ISO 10545-9 | | Metodo di prova disponibile . Test method available Méthode d'essai disponible . Prüfverfahren verfügbar | | Conforme . According to Conforme . Gemäss | |
| Resistenza al gelo . Frost resistance Résistance au gel . Frostbeständigkeit | ISO 10545-12 | | Metodo di prova disponibile . Test method available Méthode d'essai disponible . Prüfverfahren verfügbar | | Conforme . According to Conforme . Gemäss | |
| Reazione al fuoco . Reaction to fire Réaction au feu . Brandverhalten | - | | Classe A1 oppure A1 _s - Class A1 or A1 _{fl} Categorie A1 ou A1 _{fl} - Klasse A1oder A1 _{fl} | | A1-A1 _{fl} | |
| Determinazione della resistenza chimica . Chemical resistance Résistance chimique . Chemikalienbeständigkeit | ISO 10545-13 | | Classe B minimo Class B min Classe B min Klasse B min | | A LA HA | |
| Determinazione della resistenza alle macchie Resistance to staining Résistance aux taches . Beständigkeit gegen Fleckenbil | ISO 10545-14 | | Classe 3 minimo . Class 3 min Classe 3 min . Klasse 3 min | | Conforme . According to Conforme . Gemäss | |
| Resistenza allo scivolamento . Slip resistance Résistance au glissement . Bestimmung der Rutschemmungsfähigkeit | EN 16165 (previously DIN 51130) | | Classificazione R . Classification R Evaluación R . Klassifizierung R | | R10 | |
| Resistenza allo scivolamento - superfici bagnate calpestio a piedi scalzi Résistance au glissement - surfaces mouillées passage à pieds nus Bestimmung der Rutschemmungsfähigkeit - nasse Oberfläche - Barfuß-gehen Coefficient of friction - dry surfaces walking on barefoot | EN 16165 (previously DIN 51097) | | Classificazione A B C - Evaluación A B C Klassifizierung A B C - Classification A B C | | B | |
| Coefficiente di attrito dinamico Resistance de frottement dynamique Dynamischer reibungskoeffizient Dynamic friction coefficient | METODO B.C.R.A | | D.M.I. Giugno 1989 n.236 (μ > 0,40) | | Conforme According to Conforme Gemäss | |
| Resistenza allo scivolamento - coefficiente di attrito dinamico (DCOF) Slip resistance - dynamic friction coefficient Résistance au glissement - resistance de frottement dynamique Bestimmung der Rutschemmungsfähigkeit - dynamischer reibungskoeffizient | ANSI A 326.3 | | ≥ 0,42 wet | | Conforme According to Conform Gemäss | |

GRADO DI VARIAZIONE CROMATICA Ogni prodotto si caratterizza per un grado di stonalizzazione variabile da prodotto a prodotto, da colore a colore.
 Per stonalizzazione s'intende variazione di gradazione cromatica da piastrella a piastrella. DEGRÉ DE VARIATION CROMATIQUE Chaque produit est caractérisé par un degré de nuance variable d'un produit à l'autre et d'une couleur à une autre. Par nuance, il faut entendre une variation de la gradation de couleur entre un carreau et un autre. GRAD DER FARBARBEIHLUNG Jedes Produkt kennzeichnet sich durch einen bestimmten Grad an Marmorierung (Schattierung), der sich von Produkt zu Produkt, von Farbe zu Farbe unterscheiden kann. Unter Marmorierung versteht man den Grad der Farbänderung von Fliese zu Fliese. COLOUR SHADE VARIATION Every product is characterised by colour-shading that can vary from one product to another and from one colour to another. When referring to colour-shading we refer to the chromatic variation of the tile surface.

 Prodotto con forte stonalizzazione
 Product with a strong colour-shading
 Produit avec fortes différences de nuances
 Produkt mit starker Farbveränderung

I dati e le informazioni riportate nel presente catalogo sono aggiornate al momento della stampa e potrebbero subire successive correzioni e/o modifiche.
 Verificare sempre l'ultima edizione disponibile confrontando la data riportata nell'ultima pagina della versione cartacea, con quella indicata nel pdf del catalogo scaricabile dal sito www.supergres.com

I colori e le caratteristiche estetiche dei prodotti sono indicativi e si avvicinano quanto più possibile a quelli reali nei limiti consentiti dai processi di stampa.

Data and information reported in this catalogue are updated at the moment of catalogue printing therefore they may be subject to subsequent corrections and/or amendments. Always check the latest available issue and compare the date reported on the last page of the hard-paper copy of the catalogue with that stated in the pdf. format downloadable on website www.supergres.com

The colours and aesthetic features of products are indicative and reproduce, as close as possible, the real colours and features taking into consideration the restrictions of printing processes.

Finito di stampare a Modena (MO) nel mese di Settembre 2024 per conto di Ceramiche Supergres - Strada Statale 467, n° 34 - 42013 Casalgrande (RE) Italy

I prodotti, i marchi e le immagini riprodotte nel presente catalogo sono tutelati ai sensi della normativa vigente in materia di proprietà intellettuale. Ogni violazione degli stessi verrà perseguita a norma di legge.

Printed in Modena (MO) in the month of September 2024 by on behalf of Ceramiche Supergres - Strada Statale 467, n° 34 - 42013 Casalgrande (RE) Italy

All products, trade-marks and photographs reproduced in this catalogue are subject to all existing intellectual property laws. Any breach thereof will be dealt with under the provisions provided by such law.

© Copyright 2024 Ceramiche Supergres Casalgrande (Reggio Emilia) - Italy
 Pubblicato da Ceramiche Supergres. Strada Statale 467, n° 34 - 42013 Casalgrande (RE) Italy - Aprile 2024
 Progetto, direzione e coordinamento a cura dell'ufficio marketing Ceramiche Supergres

© Copyright 2024 by Ceramiche Supergres Casalgrande (Reggio Emilia) - Italy
 Published by Ceramiche Supergres. Strada Statale 467, n° 34 - 42013 Casalgrande (RE) Ital - April 2024
 Project, management and co-ordination by marketing Ceramiche Supergres



Distribuitor în România – Gada Ceramic București, Str. Vlad Județu 48
Website: www.gadaceramic.ro

CTIR/01 - SETTEMBRE 2024

Office
Strada Statale 467, 34
42013 Casalgrande (RE) Italy
Ph. +39 0522 997411
Fax Export +39 0522 997415
Fax Italia +39 0522 997494

Warehouse
Via dell'Industria, 1 - Villaggio Macina
42013 Salvaterra di Casalgrande (RE) Italy

info@supergres.com
www.supergres.com

CERAMICHE
SUPERGRES