

Distribuitor în România – Gada Ceramic București, Str. Vlad Județu 48
Website: www.gadaceramic.ro

WHISPER

Architectural Echoes



CERAMICHE
SUPERGRES

WHISPER

Architectural Echoes

Introduction

Gallery

Technical specifications

Ceramics. A safe choice.

Sustainability

Our Idea Architectural Echoes

Whisper è un'armonia sussurrata che trasforma gli spazi in oasi di benessere.
I colori caldi e le texture morbide creano architetture senza tempo,
evocando atmosfere rilassanti.

Whisper is a gentle combination that turns rooms into oases of wellbeing. Its cozy and warm colours and soft textures build timeless architecture and evoke calm of relaxation.

Whisper, c'est une harmonie susurrée qui transforme les espaces en oasis de bien-être. Les couleurs chaudes et les textures douces créent des architectures intemporelles, évocatrices d'atmosphères reposantes.

Whisper verbreitet eine leise, harmonische Stimmung, die Räume in Wohlfühlöasen verwandelt. Die warmen Farben und weichen Texturen gestalten zeitlose Interieurs im Zeichen von Ruhe und Entspannung.

Our Inspiration

Nature Enhancing Beauty

Le texture delicate trasportano l'eleganza equilibrata della pietra di ispirazione nel mondo dell'architettura contemporanea.

La collezione riproduce alla perfezione l'estetica della pietra limestone francese, con venature essenziali, colori naturali, sfumature tono su tono.

The delicate textures bring the immaculate elegance of the inspiration stone into the world of contemporary architecture. The collection perfectly replicates the look of French limestone, with demure vein patterns, natural colours and tone-on-tone shade variation.

Les textures délicates transposent l'élégance équilibrée de la pierre d'inspiration dans le monde de l'architecture contemporaine. La collection reproduit à la perfection l'esthétique de la pierre calcaire française, avec des veines sobres, des couleurs naturelles et des nuances ton sur ton.

Die dezerten Texturen transportieren die nüchterne Eleganz der natürlichen Gesteinsvorlage in die Welt der modernen Architektur. Die Kollektion reproduziert perfekt die Optik französischen Sandsteins mit seinen schlichten Äderungen, natürlichen Farben und Ton-in-Ton-Schattierungen.

120x120RT
R10 B 9 mm
R11 C 9 mm on demand



60x120RT
R10 B 9 mm
R11 C 20 mm 
R11 C 9 mm on demand



80x80RT
R10 B 9 mm



60x60RT
R10 B 9 mm
R11 C 9 mm on demand



30x60RT
R10 B 9 mm
R11 C 9 mm on demand



Range Radiant Shades

La palette cromatica di Whisper si compone di 5 tonalità luminose e calde.
La luce naturale sottolinea i delicati dettagli grafici e conferisce agli ambienti
un'atmosfera suggestiva.



Warm

Earth

Whisper's colour assortment includes 5 warm, luminous shades. Natural light underlines the delicate details of the patterning and illuminates interiors with an enticing beauty.

La palette de couleurs de Whisper se compose de cinq teintes chaudes et lumineuses. La lumière naturelle souligne les détails graphiques délicats et confère aux pièces une atmosphère évocatrice.

Die Farbpalette von Whisper setzt sich aus fünf leuchtenden, warmen Farben zusammen. Im Tageslicht treten die zarten grafischen Details besonders gut zum Vorschein und erzeugt die Kollektion eine reizvolle Raumatmosfera.



Light



Cloud



Dune

Bordo Vintage

Il bordo irregolare vintage è disponibile sia nel formato 60x120 che nel pattern multiformato. L'effetto frastagliato dona alla superficie un aspetto autentico.

The vintage uneven edge is available for the 60x120 size and the multi-size module. This irregular look gives the surface an authentic appeal.

Le bord irrégulier vintage est proposé pour le format 60x120 et pour le module multiformat. L'effet découpé confère un aspect authentique à la surface.

Die unregelmäßige Kante in Vintage-Optik ist für das Format 60x120 und das Formatmix-Modul verfügbar. Das ungleichmäßige Aussehen verleiht dem Flächenbild eine authentische Ausstrahlung.

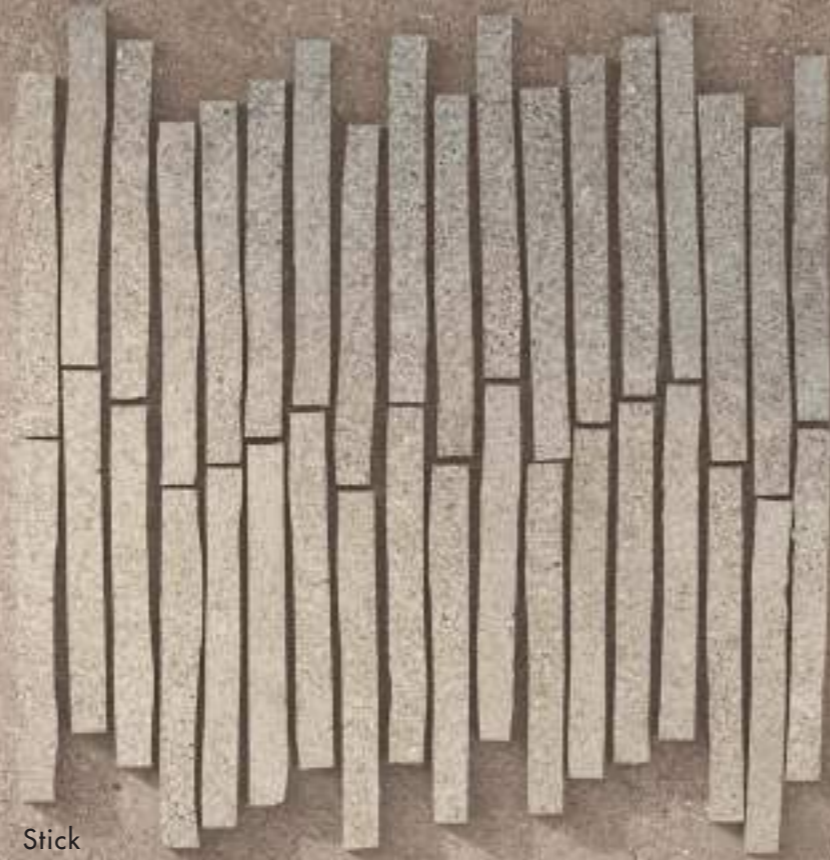

Stick

Details Shape of Vibes

Il bordo irregolare del formato 60x120 offre un look distintivo che recupera un particolare dal sapore vintage. I decori a mosaico ampliano le possibilità creative, fondendosi con l'ambiente circostante e creando un'estetica contemporanea.

Foliage

A taste of uniqueness

Le decorazioni FOLIAGE e MURAL, realizzate in gres porcellanato formato 60x120, arricchiscono e conferiscono personalità a qualsiasi tipo di ambiente, anche grazie al delicato effetto 3D.

The FOLIAGE and MURAL decorations are both made of the finest porcelain gres in the size of 60x120cm. They add a touch of beauty and personality to any type of environment. In addition, they provide a sense of authenticity with their delicate 3D design.

Réalisées en grès cérame format 60x120, les décorations FOLIAGE et MURAL enrichissent tout type d'espace et lui donnent de la personnalité. La surface, inspirée d'un mur écaillé, et son motif floral stylisé apportent du cachet à chaque environnement.

Die Dekorationen FOLIAGE und MURAL im Format 60x120 aus Feinsteinzeug ermöglichen die abwechslungsreiche, eindrucksvolle Gestaltung aller Räume. Dank der Oberfläche, die einer abgeblätterten Wand nachempfunden ist, und dem stilisierten Blumenmotiv erhält jedes Ambiente eine charakterstarke Ausstrahlung.



Mosaic



Mural

The tumbled edge of the 60x120 size provides a distinctive look, rediscovering a detail with a timeless appeal. The porcelain mosaic decorations enhance creative possibilities by blending into their surroundings and creating a modern aesthetic

Reprenant un détail d'esprit vintage, le bord irrégulier du format 60x120 offre un aspect distinctif. Les décors mosaïque élargissent les possibilités créatives, se fondant dans l'environnement et créant une esthétique contemporaine.

Die unregelmäßige Kante des Formats 60x120 weist eine markante Optik mit Vintage-Flair auf. Die Mosaikdekore erweitern die gestalterischen Möglichkeiten. Sie fügen sich nahtlos in die Umgebung und erzeugen eine zeitgemäße Anmutung.

Applications

All Around Vibration

Con il suo stile quiet luxury, Whisper è una soluzione completa e funzionale. Un'offerta per progetti residenziali e pubblici total look, con superfici coordinate per interno ed esterno.

○ Wall decor

○ Wall

○ Floor

○ Outdoor

With its style of quiet luxury, Whisper is a complete, functional solution. An offering for total-look residential and commercial projects, with matching indoor-outdoor surfaces for a complete transitioning solution.

Avec son style quiet luxury, ou luxe discret, Whisper est une solution complète et fonctionnelle. Une offre destinée à des projets résidentiels et publics total look, avec des surfaces coordonnées pour l'intérieur et l'extérieur.

Dem leisen Luxus verschworen, ist Whisper eine funktionale und umfassende Lösung. Die Kollektion ist wie geschaffen für Wohn- und Objektbereiche im All-over-Look mit aufeinander abgestimmten Innen- und Außenbereichen.

Commercial ○ Residential

Gallery Spaces to Breathe

Lasciati ispirare dall'eleganza sussurrata di Whisper con una serie di ambientazioni residenziali e commerciali che offrono un rifugio dal ritmo frenetico della vita quotidiana.



Balanced Living Room
Whisper Earth, Warm



Peaceful Open Space
Whisper Cloud



Refined Commercial Hub
Whisper Warm

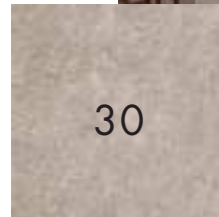

Soothing Garden Lounge
Whisper Warm T20

Be inspired by Whisper's discrete elegance, with a series of residential and commercial design schemes that provide an escape from the frenetic pace of daily life.

Laissez-vous inspirer par l'élégance susurrée de Whisper dans une série d'espaces résidentiels et commerciaux, qui offrent un refuge contre le rythme effréné de la vie quotidienne.

Lassen Sie sich von der leisen Eleganz von Whisper durch einige Interieurs aus dem Wohnungs- und Objektbau inspirieren, die ein Refugium vom Alltagsstress bieten.



Pure Home Oasis
Whisper Light



Poolside Haven
Whisper Dune T20



Calm Reading Retreat
Whisper Earth

Embrace the Harmony with a Choreography of Natural Shades



FLOOR: Earth 60x120RT - 24"x48" WALL: Warm 60x120RT - 24"x48"



Harmonious Blend of Shades to Experience the Difference



FLOOR: Cloud Pattern Bordo Vintage





FLOOR: Cloud Pattern Bordo Vintage WALL: Cloud Stick 30x34 - 12"x13,6"

Heritage of Craftsmanship Meets Contemporary Design



FLOOR: Warm Bordo Vintage 60x120 - 24"x48" WALL: Warm 60x120RT - 24"x48"





FLOOR: Warm Bordo Vintage 60x120 - 24"x48" WALL: Warm 60x120RT - 24"x48"

Shaping Spaces toward In&Out Dialogues



FLOOR: Warm T_20 60x120RT - 24"x48" | Serie 4Ever Havana T_20 30x120TY - 12"x48"





FLOOR: Warm T_20 60x120RT - 24"x48" | Havana T_20 30x120TY - 12"x48" Serie 4Ever

Lights on Emotions over Uncontaminated Natural Landscape



FLOOR: Light 60x120RT - 24"x48" WALL: Foliage 60x120RT - 24"x48" | Light Stick 30x34 - 12"x13,6"



An Experience of Endless Serenity with a Seamless Design



FLOOR: Dune T_20 60x120RT - 24"x48" WALL: Mural 60x120RT - 24"x48" | Dune Stick 30x34 - 12"x13,6"





FLOOR: Dune T_20 60x120RT - 24"x48" WALL: Mural 60x120RT - 24"x48" | Dune Stick 30x34 - 12"x13,6"



A Haven where Shared Stories Begins



Earth 120x120RT - 48"x48"





Earth 120x120RT - 48"x48"

light

cloud

GRES PORCELLANATO | PORCELAIN TILES
GRÈS CÉRAME | FEINSTEINZEUG

R10 B | 9 mm \pm | 120x120RT | 80x80RT | 60x120RT | 60x60RT | 30x60RT
GRIP R11 C | 9 mm \pm | 120x120RT | 60x120RT | 60x60RT | 30x60RT disponibile su richiesta / available upon request
R11 C | 20 mm \pm | 60x120RT



120x120RT
48"x48"



80x80RT
32"x32"

T-20



60x120RT
24"x48"



60x60RT
24"x24"



30x60RT
12"x24"



60x120RT
24"x48"

GRES PORCELLANATO | PORCELAIN TILES
GRÈS CÉRAME | FEINSTEINZEUG

R10 B | 9 mm \pm | 120x120RT | 60x120RT | 60x60RT | 30x60RT
GRIP R11 C | 9 mm \pm | 120x120RT | 60x120RT | 60x60RT | 30x60RT disponibile su richiesta / available upon request



120x120RT
48"x48"



60x120RT
24"x48"



60x60RT
24"x24"



30x60RT
12"x24"

dune

warm

GRES PORCELLANATO | PORCELAIN TILES
GRÈS CÉRAME | FEINSTEINZEUG

R10 B | 9 mm \pm | 120x120RT | 80x80RT | 60x120RT | 60x60RT | 30x60RT
GRIP R11 C | 9 mm \pm | 120x120RT | 60x120RT | 60x60RT | 30x60RT disponibile su richiesta / available upon request
R11 C | 20 mm \pm | 60x120RT



120x120RT
48"x48"



80x80RT
32"x32"

T-20



60x120RT
24"x48"



60x60RT
24"x24"

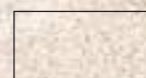

30x60RT
12"x24"



60x120RT
24"x48"

GRES PORCELLANATO | PORCELAIN TILES
GRÈS CÉRAME | FEINSTEINZEUG

R10 B | 9 mm \pm | 120x120RT | 80x80RT | 60x120RT | 60x60RT | 30x60RT
GRIP R11 C | 9 mm \pm | 120x120RT | 60x120RT | 60x60RT | 30x60RT disponibile su richiesta / available upon request
R11 C | 20 mm \pm | 60x120RT



120x120RT
48"x48"



80x80RT
32"x32"

T-20



60x120RT
24"x48"



60x60RT
24"x24"

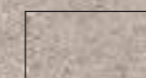

30x60RT
12"x24"



60x120RT
24"x48"

earth

GRES PORCELLANATO | PORCELAIN TILES
GRÈS CÉRAMÉ | FEINSTEINZEUG

R10 B | 9 mm ÷ | 120x120RT | 60x120RT | 60x60RT | 30x60RT
GRIP R11 C | 9 mm ÷ | 120x120RT | 60x120RT | 60x60RT | 30x60RT disponibile su richiesta / available upon request



120x120RT
48"x48"



60x120RT
24"x48"



60x60RT
24"x24"



30x60RT
12"x24"

Decors Whisper

GRES PORCELLANATO | PORCELAIN TILES
GRÈS CÉRAMÉ | FEINSTEINZEUG

9 mm ÷ | 60x120RT

Mural



Mural
60x120RT . 24"x48"

Foliage



Foliage
60x120RT . 24"x48"

matching floor

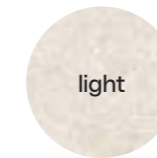

light



dune

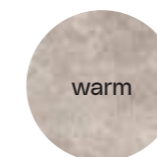

warm

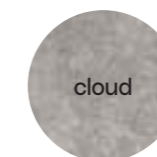

cloud

matching floor

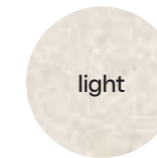

light



dune

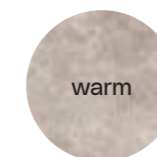

warm

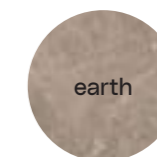

earth

Mosaici Whisper

GRES PORCELLANATO | PORCELAIN TILES
GRÈS CÉRAME | FEINSTEINZEUG

9 mm ±

Mosaico



Mosaico Light
30x30 . 12"x12"



Mosaico Cloud
30x30 . 12"x12"



Mosaico Dune
30x30 . 12"x12"



Mosaico Warm
30x30 . 12"x12"



Mosaico Earth
30x30 . 12"x12"

Stick



Stick Light
30x34 . 12"x13,6"



Stick Cloud
30x34 . 12"x13,6"



Stick Dune
30x34 . 12"x13,6"



Stick Warm
30x34 . 12"x13,6"



Stick Earth
30x34 . 12"x13,6"

T.20

Whisper

GRES PORCELLANATO | PORCELAIN TILES
GRÈS CÉRAME | FEINSTEINZEUG

20 mm ± | R11 C

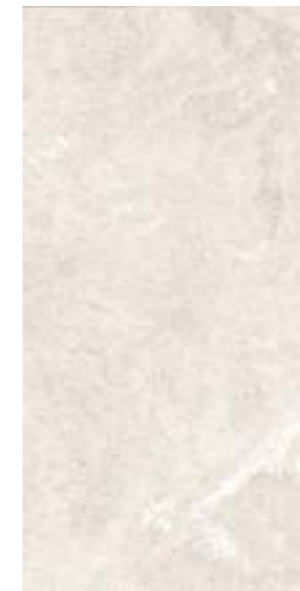

Light T_20
60x120RT . 24"x48"

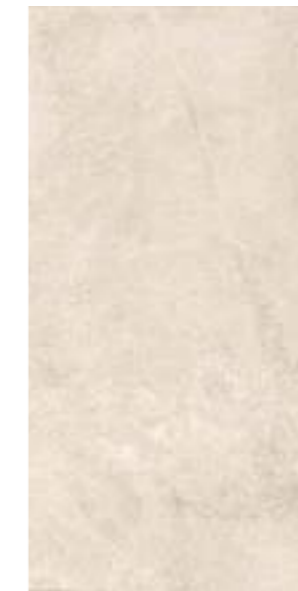

Dune T_20
60x120RT . 24"x48"



Warm T_20
60x120RT . 24"x48"

Per dettagli sul prodotto in 20 mm di spessore e sui relativi sistemi di posa ed, in particolare, per le raccomandazioni, accorgimenti, limitazioni di utilizzo e precauzioni in fase di posa, si raccomanda di prendere visione dell'ultima versione del catalogo T20 e del sito

www.supergres.com

Pour de plus amples détails sur les produits de 20 mm d'épaisseur et sur leurs systèmes de pose, et en particulier, pour les recommandations, mises à jour, limitations d'usage et précautions en phase de pose, veuillez prendre connaissance de la dernière version du catalogue T20 et du site www.supergres.com
Für Details zum Produkt mit 20 mm Stärke und entsprechende Verlegesysteme, insbesondere hinsichtlich Hinweise und Anmerkungen, Nutzungseinschränkungen und Vorsichtsmaßnahmen während der Verlegung, wird die Einsicht der letzten Version des Katalogs T20 und der Webseite www.supergres.com empfohlen.

For further details on the 20 mm product and the installation systems, in particular for recommendations, restrictions of use, and precautions during installation, please refer to www.supergres.com and to the latest release of T20 catalogue.

Bordo Vintage Whisper

Il bordo irregolare "vintage" è ottenuto con un innovativo processo industriale che scalfisce lo spessore della piastrella e conferisce un sapore artigianale alla collezione Whisper. Ogni pezzo è unico e diverso dagli altri.

Il bordo vintage è disponibile su tutti i colori della collezione, sia sul formato 60x120 che sul modulo multiformato di mq 0,72.

Il pattern è composto da 6 pezzi (20x40, 20x60, 20x20, 20x40, 40x40 e 40x60) e può essere posato seguendo diversi schemi di posa, che riportiamo di seguito. Per la posa del materiale con bordo vintage si consiglia una fuga di 3 mm.

La fuga larga esalta l'effetto frastagliato del bordo e può essere stuccata con stucco perfettamente a tono, o a contrasto per un effetto più moderno.

60x120 BORDO VINTAGE



60x120RT . 24"x48"

Available in all colors
Disponibili in tutti i colori

PATTERN BORDO VINTAGE



Bordo Vintage Whisper



The vintage uneven edge is created through an innovative process that cuts into the entire depth of the tile, giving the Whisper collection a handmade feel. Each piece is unique and different from the others. The vintage edge is available in all colors of the collection, in both the 60x120 size and the 0.72 m² multi-size module.

The pattern consists of 6 pieces (20x40, 20x60, 20x20, 20x40, 40x40, and 40x60) and can be laid out in various designs, as shown below. A 3 mm joint is recommended when installing tiles with a vintage edge. The wide joint accentuates the rugged effect of the edge and can be filled with grout in a matching color or a contrasting shade for a more contemporary appearance.

Le bord irrégulier « vintage » est obtenu par un processus industriel innovant qui réduit l'épaisseur du carreau, donnant ainsi à la collection Whisper son aspect artisanal. Chaque pièce est unique et ne ressemble à aucune autre. Le bord vintage est proposé pour toutes les couleurs de la collection, tant sur le format 60x120 que sur le module multiformat de 0,72 m². Le motif, composé de 6 pièces (20x40, 20x60, 20x20, 20x40, 40x40 et 40x60) peut être posé selon les différents schémas de pose présentés ci-dessous. Une largeur de joint de 3 mm est recommandée pour la pose du matériau avec un bord vintage. Le joint large accentue l'effet découpé du bord. Il peut être jointoyé avec un mortier parfaitement assorti, ou contrasté pour un effet plus moderne.

Der unregelmäßigen Kante im Vintage-Look liegt ein innovatives Fertigungsverfahren zugrunde, bei dem die Fliese leicht zerkratzt wird, was der Kollektion Whisper eine handwerkliche Anmutung verleiht. Jedes Exemplar ist einzigartig und besitzt Unikatcharakter. Die Vintage-Kante ist für alle Farben der Kollektion im Format 60x120 und im 0,72 m² großen Formatmix-Modul erhältlich. Das Fugenmuster besteht aus sechs Teilen (20x40, 20x60, 20x20, 20x40, 40x40 und 40x60) und kann in verschiedenen Verlegebildern verlegt werden, siehe weiter unten. Für die Verlegung von Fliesen mit Vintage-Kante wird eine Fugenbreite von 3 mm empfohlen. Die breite Fuge betont die unregelmäßige Kante. Die Fugenmasse kann entweder Ton in Ton in Abstimmung auf die Fliesenfarbe oder in einer Kontrastfarbe gewählt werden, wenn ein moderner Effekt gewünscht wird.

Whisper

SCHEMI DI POSA CONSIGLIATI | SUGGESTED INSTALLATION SCHEME

Modulo 1

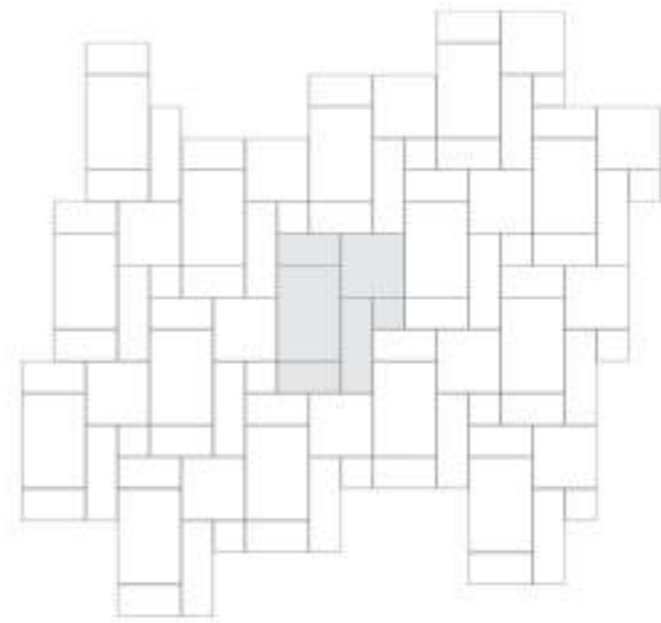
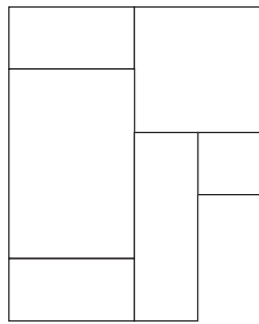

Modulo 2

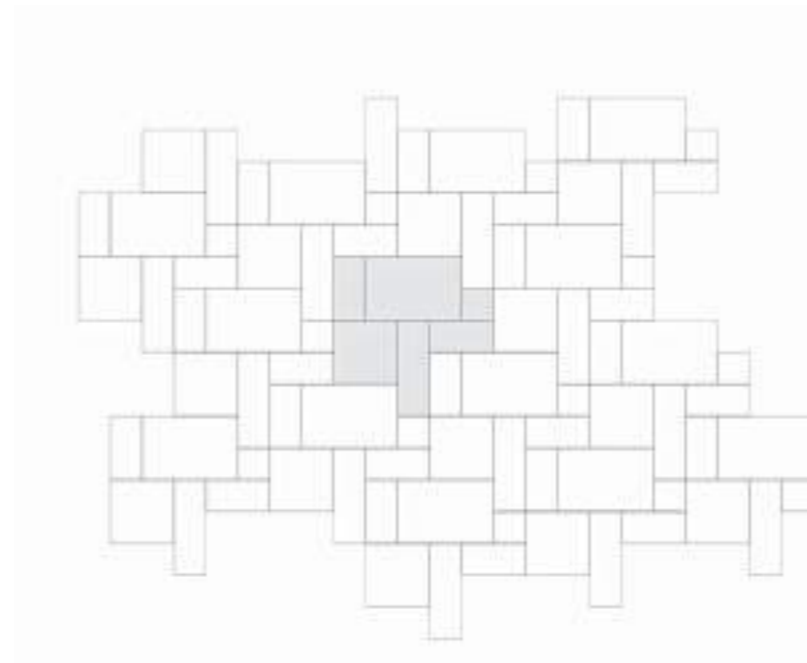
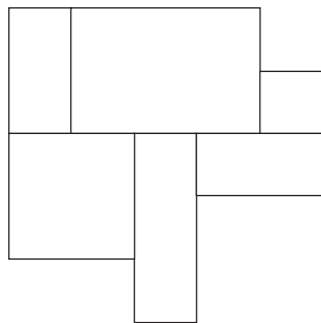

Modulo 3

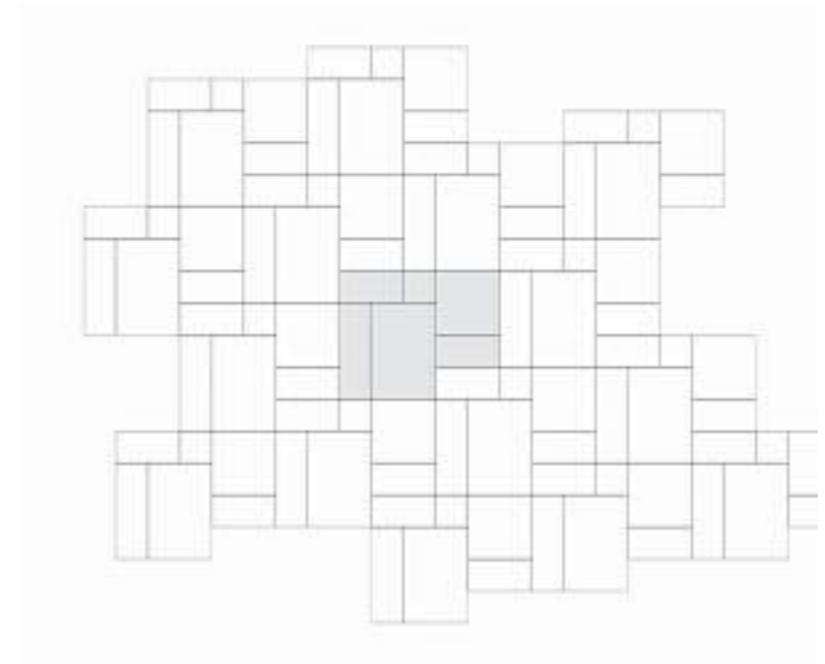
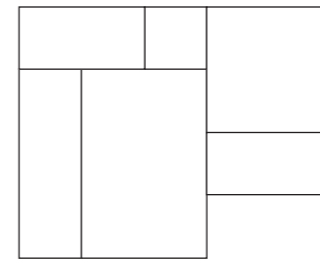

Modulo 4

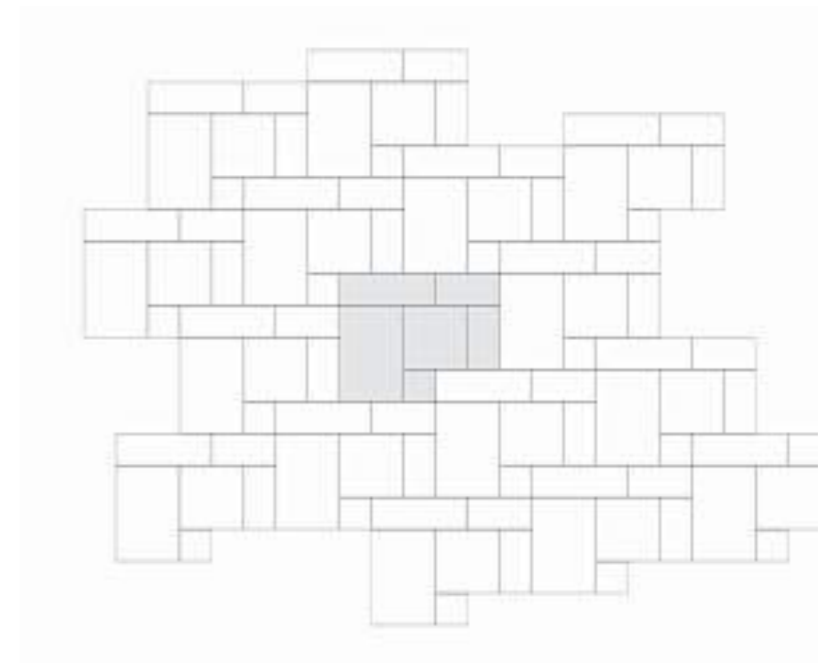
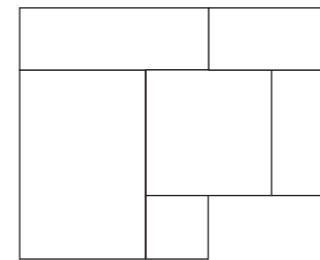

Range Whisper

GRES PORCELLANATO | PORCELAIN TILES
GRÈS CÉRAME | FEINSTEINZEUG

9 mm | 20 mm

	120x120RT 48"x48" 9 mm	80x80RT 32"x32" 9 mm	60x120RT 24"x48" 9 mm	60x60RT 24"x24" 9 mm	30x60RT 12"x24" 9 mm	60x120RT 24"x48" 20 mm
light	■	■	■	■	■	■
cloud	■	■	■	■	■	■
dune	■	■	■	■	■	■
warm	■	■	■	■	■	■
earth	■	■	■	■	■	■

Trims Whisper

PEZZI SPECIALI | TRIMS
PIÈCES SPÉCIALES | FORMSTÜCKE

9 mm

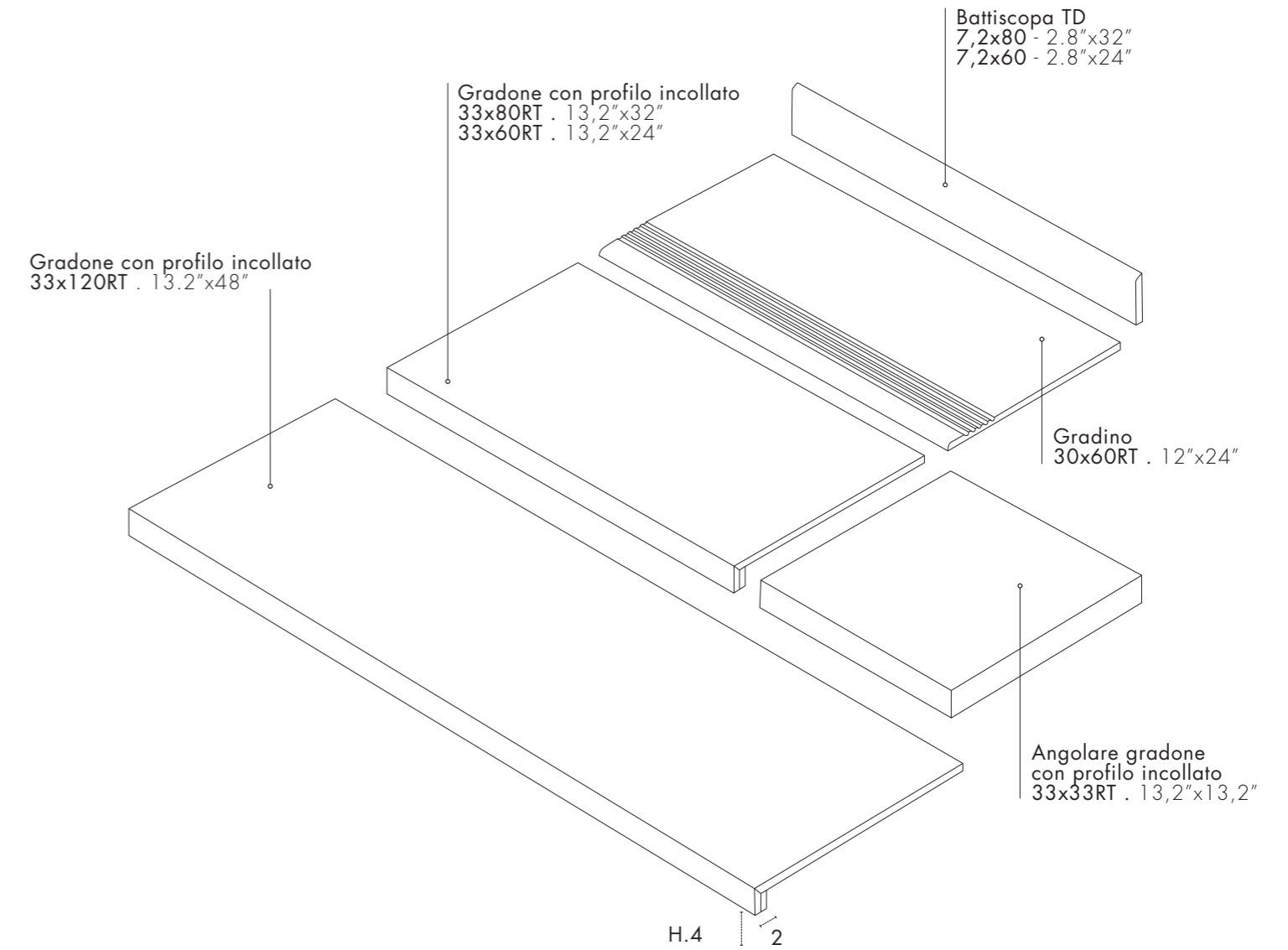

Disponibili su tutti i colori, su ordinazione
Available in all colours, on demand

AVVERTENZE PER LA POSA | RECOMMENDATIONS FOR INSTALLATION
RECOMMANDATIONS POUR L'INSTALLATION | EMPFEHLUNGEN FÜR DIE INSTALLATION.

Per la posa del materiale rettificato si prescrive una fuga minima di 2 mm.
As for rectified materials, a minimum joint of 2 mm is required.
Pour la pose du matériau rectifié, il faut réaliser un joint minimum de 2 mm.
Für die Verlegung des geschliffenen Materials ist eine Mindestfuge von 2 mm vorgeschrieben.

Packing Whisper

IMBALLI | PACKING
EMBALLAGE | VERPACKUNG

GRES PORCELLANATO | PORCELAIN TILES
GRÈS CÉRAMÉ | FEINSTEINZEUG

	spessore	pz/box	mq/sc	kg/sc	sc/plt	mq/plt	kg/plt
120x120RT	9 mm	2	2,88	60,00	20	57,60	1212
60x120RT	9 mm	2	1,44	30,00	35	50,40	1062
80x80RT	9 mm	2	1,28	25,50	48	61,44	1236
60x60RT	9 mm	3	1,08	22,00	40	43,20	892
30x60RT	9 mm	7	1,26	25,00	40	50,40	1012
Mural / Foliage 60x120RT	9 mm	2	1,44	30,00	35	50,40	1062
60x120 Bordo Vintage	9 mm	2	1,44	30,00	-	-	-
Pattern Bordo Vintage	9 mm	1	0,72	14,00	-	-	-
Mosaico su rete 30x30RT	9 mm	10	0,90	16,00	30	27,00	495
Stick 30x34	9 mm	6	-	-	-	-	-
Gradone c/profilo incollato 33x120RT	9 mm	2	-	-	-	-	-
Gradone c/profilo incollato 33x60RT	9 mm	4	-	-	-	-	-
Angolo Gradone c/profilo incollato 33x30RT	9 mm	4	-	-	-	-	-
Gradino 30x60RT	9 mm	7	-	-	-	-	-
Battiscopa total dek 7,2x60	9 mm	10	6,00 ml	9,40	70	420 ml	673
Battiscopa total dek 7,2x80	9 mm	8	6,40 ml	7	72	460,80 ml	519
60x120RT 	20 mm	1	0,72	32	35	25,20	1135



Mural 60x120RT 24"X48"

Ceramics. A safe choice.



IGIENICA Hygienic

La ceramica è facile da pulire, igienica e pratica; basta un semplice detergente neutro per rimuovere lo sporco e facilmente ritorna alla sua bellezza originaria.

Ceramic material is easy to clean, hygienic and practical; all it takes is a simple, neutral detergent to remove dirt and restore it to its original splendour.

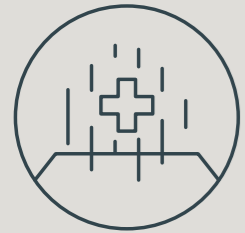

SALUBRE Healthy

Grazie alle sue caratteristiche fisiche la ceramica non rilascia alcuna sostanza nociva o VOC (sostanze organiche volatili) nell'ambiente in cui viviamo. Allo stesso modo non emette odori. Il gres porcellanato è privo di PVC, plastiche o derivati del petrolio.

Thanks to its physical characteristics, ceramic material does not release any harmful substances or VOC (volatile organic substances) into the environment we live in, nor does it give off odours. Porcelain tiles contain no PVC, plastic or petroleum derivatives.



RESISTENTE ALL'USURA Wear resistant

Il gres porcellanato è un materiale tecnico ultra compatto, altamente resistente all'usura; sopporta bene calpestio, urti, graffi e carichi pesanti.

Porcelain stoneware is an ultra-compact technical material, extremely resistant to wear, tread, shock, scratching and heavy loads.



ANTIMACCHIA Stain resistant

La ceramica non teme macchie e non viene danneggiata con l'utilizzo di solventi e detersivi.

Ceramic material is resistant to stains and is not damaged by the use of solvents and detergents.



INGELIVA Frostproof

Il gres porcellanato resiste al gelo e a tutti gli attacchi degli agenti atmosferici, ed è quindi il prodotto ideale anche in ambienti esterni.

Porcelain stoneware is resistant to frost and to all kinds of attack from the elements, making it the ideal product also for outdoors.



PRODOTTO NEL RISPETTO DELL'AMBIENTE Eco-sustainable production

Il processo produttivo aziendale impiega un sistema di raccolta e di riutilizzo degli scarti di produzione, delle acque di lavorazione e del calore generato nelle fasi di produzione. In questo modo si limita il consumo di energia e di materie prime, per un'economia più sostenibile e un ridotto impatto ambientale.

The company's production process uses a system that collects and re-uses production waste, processing water and the heat generated during the production process, thus limiting the consumption of energy and raw materials, for a more sustainable economy and lower environmental impact.



RESISTENTE AI RAGGI UV Resistant to UV rays

Esposta al sole anche per lungo tempo la ceramica non cambia colore, e mantiene inalterate nel tempo le sue caratteristiche estetiche e tecniche.

Ceramic material does not fade even after lengthy exposure to sunlight, and maintains its aesthetic and technical characteristics over time.



PRODOTTO IGNIFUGO Fireproof

Resiste al fuoco e non emette fumi in seguito alla combustione.

Resistant to fire and does not emit smoke upon combustion.



IDEALE PER RISCALDAMENTO A PAVIMENTO Ideal for underfloor heating

Ottime conduttrici di calore, il gres porcellanato si riscalda rapidamente e il calore è rilasciato immediatamente nell'ambiente; in questo modo consente di mantenere limitate temperature d'esercizio dell'impianto di riscaldamento.

An excellent conductor of heat, porcelain stoneware warms up quickly and releases heat into the air immediately, making it possible to keep the heating system working temperatures lower.

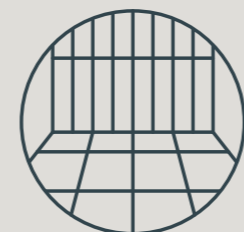

VERSATILE Versatile

La ceramica consente tante variazioni di stile e design, grazie all'ampia disponibilità di formati, spessori, finiture e tinte. Inoltre può essere utilizzata in qualsiasi ambiente, sia a pavimento che a rivestimento, in interno o esterno, in ambienti residenziali o pubblici.

All sorts of style and design variants are possible with ceramics, thanks to the wide availability of different sizes, thicknesses, finishes and colours. It can also be used anywhere, on both floors and walls, indoors or outdoors, in residential or public settings.

Sustainability

RESPONSIBILITY IS WHAT WE DO

Responsabilità è ciò che facciamo ogni giorno.
Non solo un dovere, ma un impegno per fare la differenza,
creando un ambiente sano e sicuro dove tutti possano vivere,
lavorare e realizzarsi. Adottare un nuovo mindset e scegliere
l'alternativa più sostenibile è un vero atto di responsabilità.

Un atto di responsabilità globale, perché le sfide
che affrontiamo non hanno confini.

Un atto di responsabilità territoriale, perché vogliamo fare la
differenza con il nostro lavoro, per le persone, l'ambiente e le
comunità che ci circondano.



Responsibility is what we do every day.
A commitment to make a difference, creating a healthy and safe environment
where everyone can live, work, and thrive. Adopting a new mindset and choosing
the most sustainable alternative is a true act of responsibility.

An act of global responsibility, because the challenges
we face have no boundaries.

An act of territorial responsibility, because we want to make a difference with our
work, for the people, the environment, and the communities that surround us.



GRES PORCELLANATO | PORCELAIN TILES | GRÈS CÉRAME | FEINSTEINZEUG



Ceramics of Italy

CERAMICHE
SUPERGRES
MADE in ITALY

Norma di riferimento: EN 14441 (ISO 13006) Allegato G
Piastrille di ceramica pressate a secco con basso assorbimento d'acqua (E ≤ 0,5%)

Reference standard: EN 14441 (ISO 13006) Appendix G - Dry pressed ceramic tiles with low water absorption (Ev ≤ 0,5%) .

GRUPPO B Ia

CARATTERISTICHE TECNICHE Technical characteristics . Caracteristiques techniques Technische eigenschaften	NORMA Norms . Normes Normen	REQUISITI RICHIESTI Requirements . Conditions requisés Geforderte eigenschaften			VALORE MEDIO SUPERGRES * Average rating . Valeur moyenne Durchschnittswert		
		7 cm ≤ N < 15 cm	N ≥ 15 cm				
Lunghezza e larghezza dei lati . Length and width of the sides Longuer et largeur de côtés . Länge und Breite	ISO 10545-2	RETTIFICATI	± 0,4 mm	± 0,3 %	± 1,0 mm	Conforme . According to Conforme . Gemäss	
Rettilineità degli spigoli . Straightness Equerrage des angles . Kantengeradheit			± 0,4 mm	± 0,3 %	± 0,8 mm	Conforme . According to Conforme . Gemäss	
Ortogonalità** . Rectangularity** Orthogonalité . Rechtwinkligkeit			± 0,4 mm	± 0,3 %	± 1,5 mm	Conforme . According to Conforme . Gemäss	
Planarità . Flatness Planéité . Planität			± 0,6 mm	± 0,4 %	± 1,8 mm	Conforme . According to Conforme . Gemäss	
Spessore . Thickness Epaisseur . Stärke	ISO 10545-2		± 0,5 mm	± 5 %	± 0,5 mm	Conforme . According to Conforme . Gemäss	
Assorbimento % d'acqua . Water absorption Absorption d'eau . Wasseraufnahme	ISO 10545-3		Ev ≤ 0,5%			Conforme . According to Conforme . Gemäss	
Determinazione della resistenza a flessione e della forza di rottura Flexion and break resistance Résistance à la flexion et à la force de rupture Biegefestigkeit und Bruchlast	ISO 10545-4		Spessore ≥ 7,5 mm $\left[\begin{array}{l} S \geq 1300 \\ R \geq 35 \text{ N/mm}^2 \end{array} \right.$ Thickness Epaisseur < 7,5 mm $\left[\begin{array}{l} S \geq 700 \text{ N} \\ R \geq 35 \text{ N/mm}^2 \end{array} \right.$ Stärke			Conforme . According to Conforme . Gemäss	
Determinazione della resistenza all'abrasione Abrasion Resistance Résistance à l'abrasion Abriebfestigkeit	ISO 10545-6		≤ 175 mm ³			Conforme . According to Conforme . Gemäss	
Coefficiente di espansione termica lineare tra 20° e 100° C Linear thermal expansion 20°C to 100°C Dilatation thermique linéaire entre 20°C et 100°C Lineare Waerme-ausdehnung zwischen 20°C und 100°C	ISO 10545-8		Metodo di prova disponibile . Test method available Méthode d'essai disponible . Prüfverfahren verfügbar			Conforme . According to Conforme . Gemäss	
Resistenza agli sbalzi termici . Thermal shock resistance Résistance aux écarts de Température . Temperaturwechselbestaendigkeit	ISO 10545-9		Metodo di prova disponibile . Test method available Méthode d'essai disponible . Prüfverfahren verfügbar			Conforme . According to Conforme . Gemäss	
Resistenza al gelo . Frost resistance Résistance au gel . Frostbeständigkeit	ISO 10545-12		Metodo di prova disponibile . Test method available Méthode d'essai disponible . Prüfverfahren verfügbar			Conforme . According to Conforme . Gemäss	
Determinazione della resistenza chimica . Chemical resistance Résistance chimique . Chemikalienbeständigkeit	ISO 10545-13		B min.			A LA HA	
Reazione al fuoco . Reaction to fire Réaction au feu . Brandverhalten			Classe A1 o A1 fl . Class A1 o A1 fl Classe A1 ou A1 fl . Klasse A1 oder A1 fl			Conforme . According to Conforme . Gemäss	
Determinazione della resistenza alle macchie . Resistance to staining Résistance aux taches . Beständigkeit gegen Fleckenbil	ISO 10545-14		Classe 3 minimo . Class 3 min Classe 3 min . Klasse 3 min			Conforme . According to Conforme . Gemäss	
Resistenza allo scivolamento . Slip resistance Résistance au glissement . Bestimmung der Rutschemmungsfähigkeit	EN 16165 (Previously DIN 51130)		Classificazione R . Classification R Evaluación R R . Klassifizierung R			R10	R11
Resistenza allo scivolamento - superfici bagnate calpestio a piedi scalzi Résistance au glissement - surfaces mouillées passage à pieds nus Bestimmung der Rutschemmungsfähigkeit - nasse Oberfläche - Barfuß-gehen Coefficient of friction - dry surfaces walking on barefoot	EN 16165 (previously DIN 51097)		Classificazione A B C - Evaluación A B C Klassifizierung A B C - Classification A B C			B	C
Resistenza allo scivolamento - coefficiente di attrito dinamico (DCOF) Slip resistance - dynamic friction coefficient Résistance au glissement - resistance de frottement dynamique Bestimmung der Rutschemmungsfähigkeit - dynamischer reibungskoeffizient	ANSI A 326.3		≥ 0,42 wet			Conforme According to Conforme Gemäss	Conforme According to Conforme Gemäss
Coefficiente di attrito dinamico . Dynamic friction coefficient Resistance de frottement dynamique . Dynamischer reibungskoeffizient	METODO B.C.R.A.		D.M.I. Giugno 1989 n.236 (μ > 0,40)			Conforme According to Conforme Gemäss	Conforme According to Conforme Gemäss

GRADO DI VARIAZIONE CROMATICA. Ogni prodotto si caratterizza per un grado di stonizzazione variabile da prodotto a prodotto, da colore a colore. Per stonizzazione s'intende variazione di gradazione cromatica da piastrella a piastrella.
COLOUR SHADE VARIATION. Every product is characterised by colour-shading that can vary from one product to another and from one colour to another. When referring to colour-shading we refer to the chromatic variation of the tile surface.



Prodotto con marcata variazione cromatica
Product with a marked chromatic variation

* Valori riferiti ai fondi. Le caratteristiche tecniche fanno riferimento al formato nominale delle piastrelle espresso in mm. These values refer to the bottoms. The technical characteristics refer to the nominal size of tiles expressed in mm. Valeurs se référant aux fonds. Les caractéristiques techniques se réfèrent au format nominal des carreaux exprimé en mm. Werte bezogen auf Grundfliesen. Die Angaben beziehen sich auf die Nenngröße der Fliesen in mm.

Se non indicato diversamente, i valori delle prove tecniche si riferiscono alla superficie naturale. Unless otherwise indicated, the values of technical tests refer to the natural surface finish. Sauf indication contraire, les valeurs des tests techniques se rapportent à la surface naturelle. Wenn nicht anders angegeben beziehen sich die Werte der technischen Tests auf die natürliche Oberfläche.

** Per piastrelle rettangolari che abbiano il lato maggiore L ≥ 60 cm, e rapporto tra i lati ≥ 3, la misurazione dell'ortogonalità deve venire condotta solo sul lato corto. For rectangular tiles with longest side L ≥ 60 cm and a ratio length/width L/W ≥ 3, the measurement of orthogonality should only be carried out on short edges. Pour les carreaux rectangulaires qui ont le côté le plus long L ≥ 60 cm, et le rapport entre les côtés ≥ 3, la mesure de l'orthogonalité se fait seulement sur le côté le plus court. Bei rechteckigen Fliesen, mit der längsten Seite L ≥ 60 cm und einem Seitenverhältnis von ≥ 3 darf die Messung der Rechteckigkeit nur an der kurzen Seite durchgeführt werden.

Distribuitor în România – Gada Ceramic București, Str. Vlad Județu 48
Website: www.gadaceramic.ro

CTWH/01 - SETTEMBRE 2024

Office
Strada Statale 467, 34
42013 Casalgrande (RE) Italy
Ph. +39 0522 997411
Fax Export +39 0522 997415
Fax Italia +39 0522 997494

Warehouse
Via dell'Industria, 1 - Villaggio Macina
42013 Salvaterra di Casalgrande (RE) Italy

info@supergres.com
www.supergres.com

CERAMICHE
SUPERGRES